

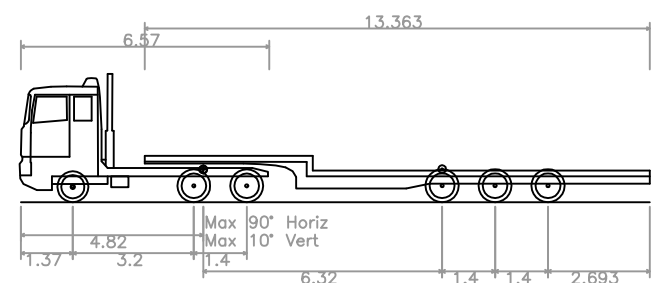

VEHICLE PROFILE

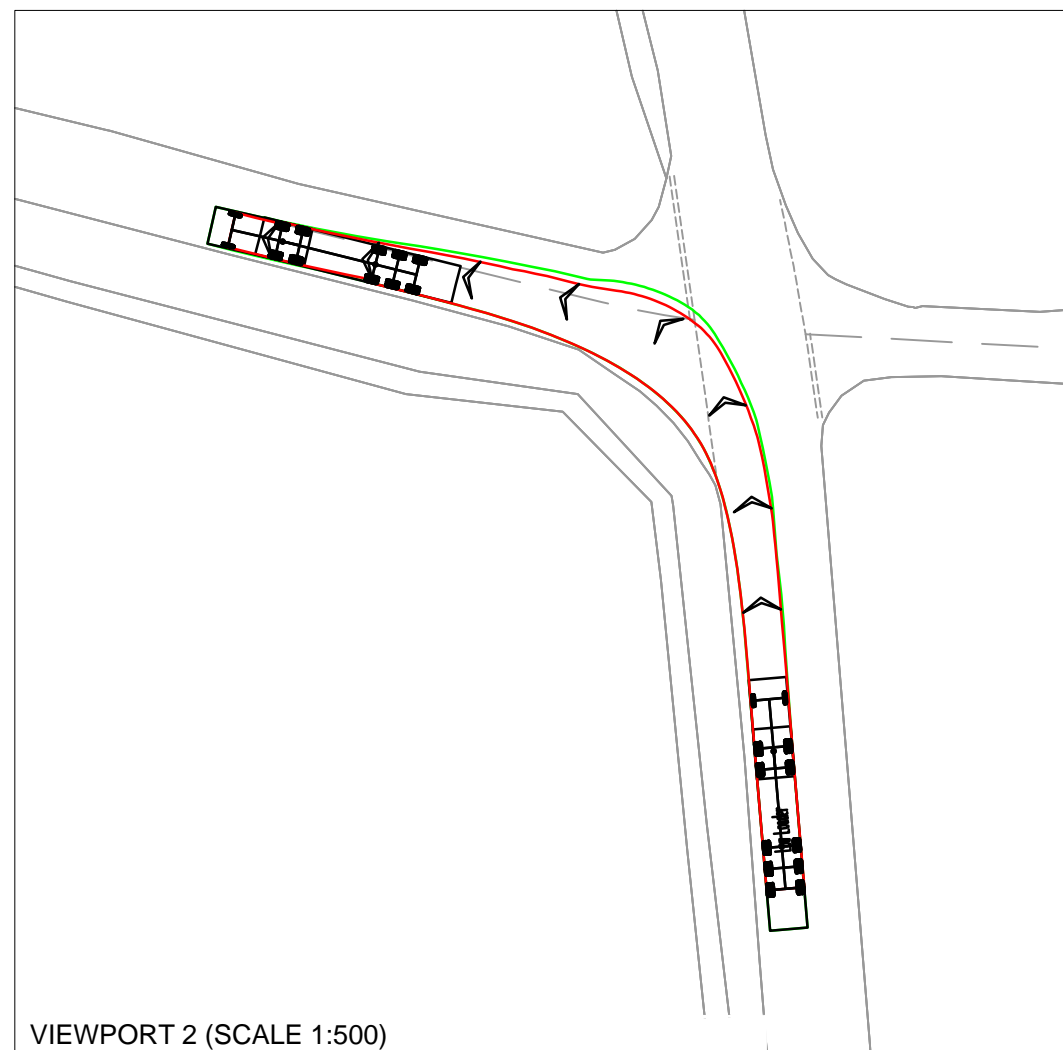

Low Loader
 Overall Length 16.633m
 Overall Width 2.500m
 Overall Body Height 3.396m
 Min Body Ground Clearance 0.320m
 Max Track Width 2.500m
 Lock to Lock Time 6.00s
 Kerb to Kerb Turning Radius 6.790m

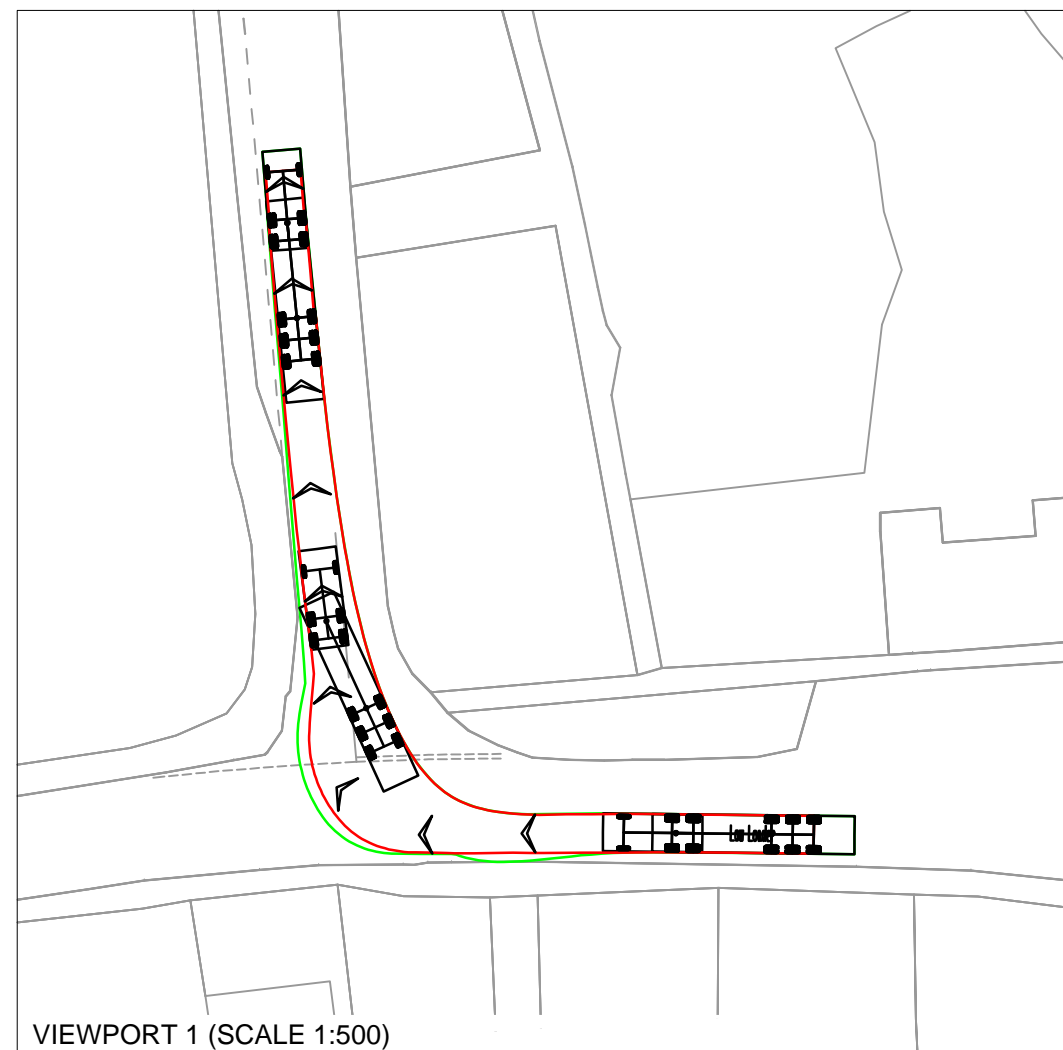
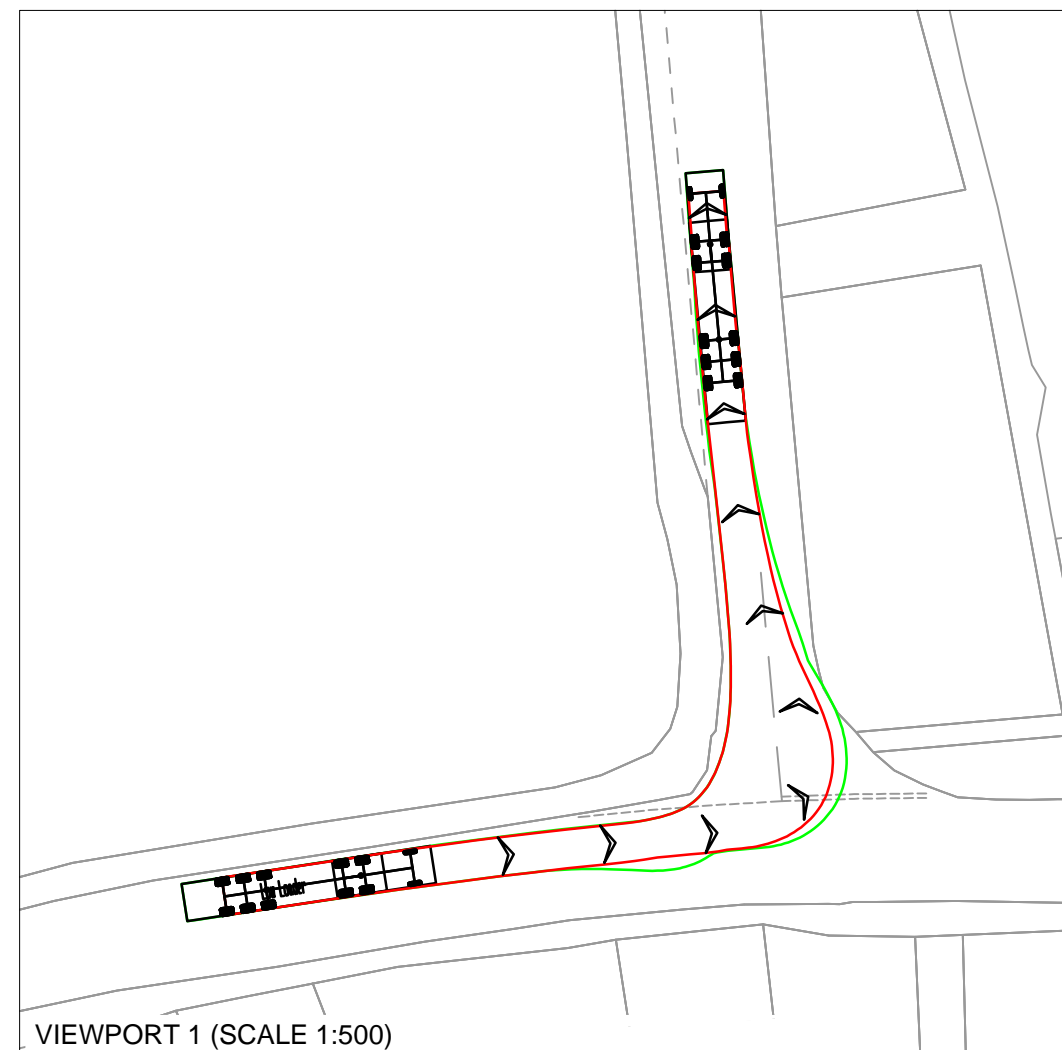

VIEWPORT SCALE - 1:1250

NOTES

REVISIONS

REV	DESCRIPTION	DATE	BY
-	-	-	-

SCP

Transportation Planning : Infrastructure Design

31 Southampton Row, London, WC1B 6HU, Tel: 020 3376 6660
 www.scptransport.co.uk, Email: info@scptransport.co.uk

Client Name:

CELTIQUE ENERGIE WEALD LIMITED

Project Title:

SOUTH DOWN CARBON EXPLORATION

Drawing Title:
 LOW LOADER ARTICULATED HGV
 SITE ACCESS ROUTE
 SWEEP PATH INFORMATION (SHEET 1 OF 2)

Date: JULY 2014 Drawn By: IW

Scale: AS SHOWN @ A1 Checked: JR

Status: PLANNING Approved: -

Drawing No: SCP/14809/SPA01 Rev: -

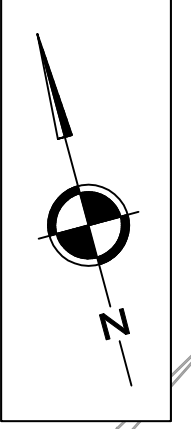
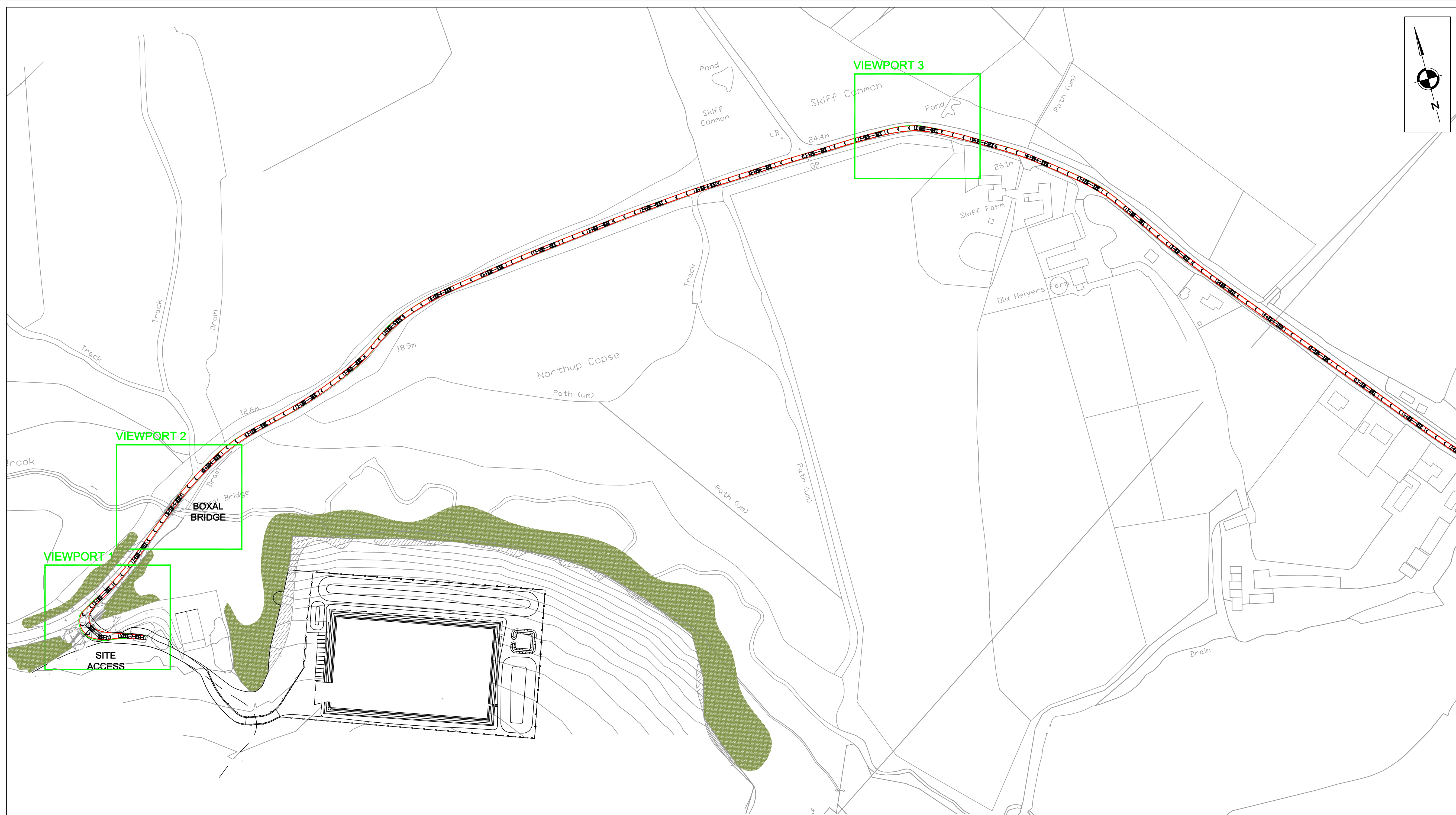

NOTES

REVISIONS

REV	DESCRIPTION	DATE	BY
-	-	-	-

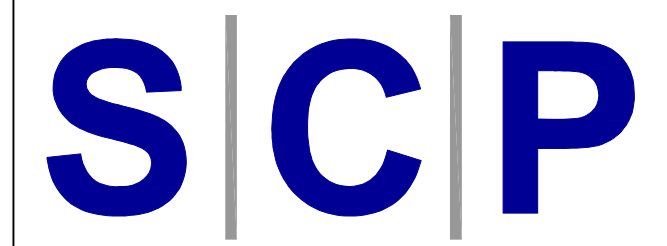

Transportation Planning : Infrastructure Design
 31 Southampton Row, London, WC1B 6HU, Tel 020 3376 6660
 www.scptransport.co.uk, Email info@scptransport.co.uk

Client Name:
 CELTIQUE ENERGIE WEALD LIMITED

Project Title:
 SOUTH DOWN CARBON EXPLORATION

Drawing Title:
 LOW LOADER ARTICULATED HGV
 SITE ACCESS ROUTE
 SWEEP PATH INFORMATION (SHEET 2 OF 2)

Date: JULY 2014	Drawn By: IW
Scale: AS SHOWN @ A1	Checked: JR
Status: PLANNING	Approved: -

Drawing No: SCP/14809/SPA02 Rev: -

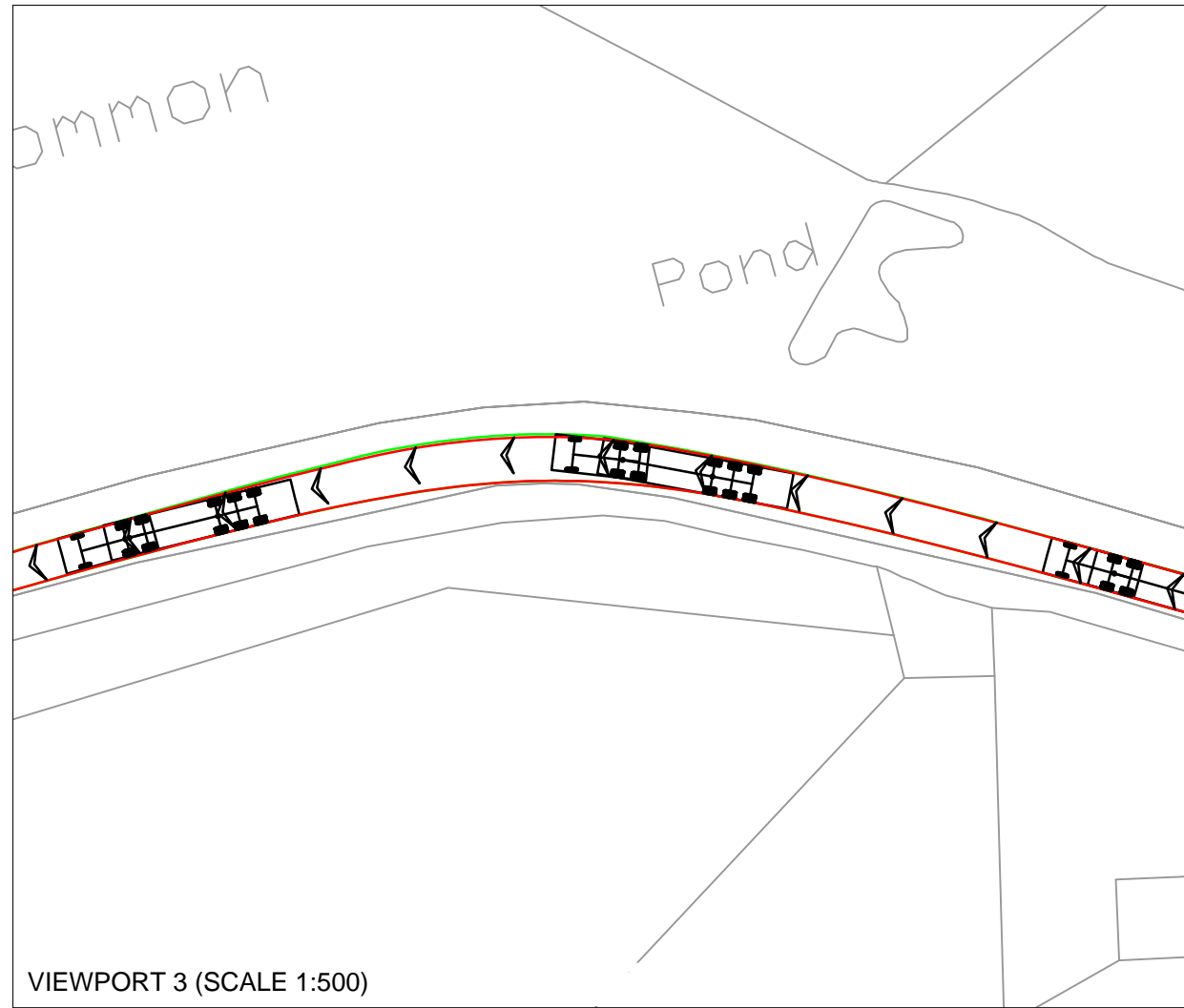
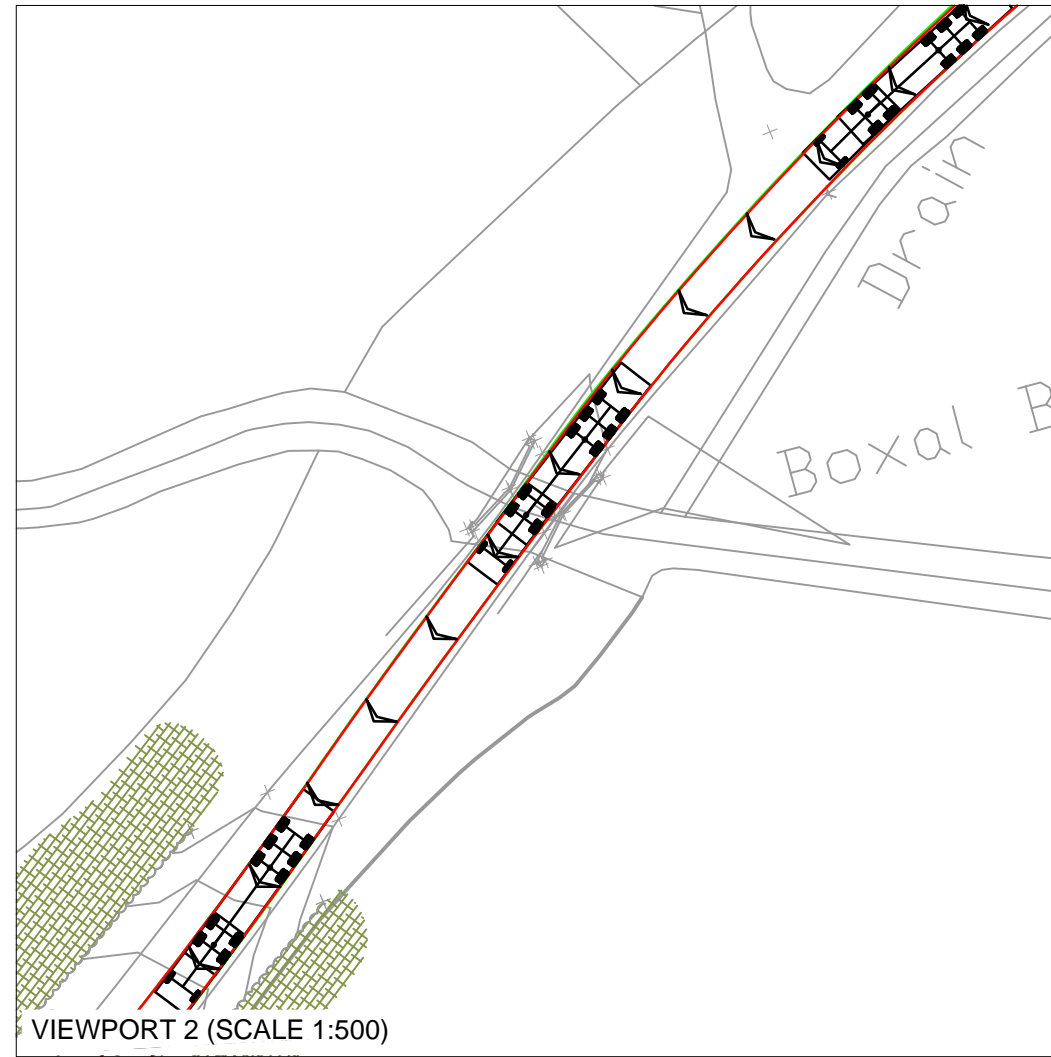
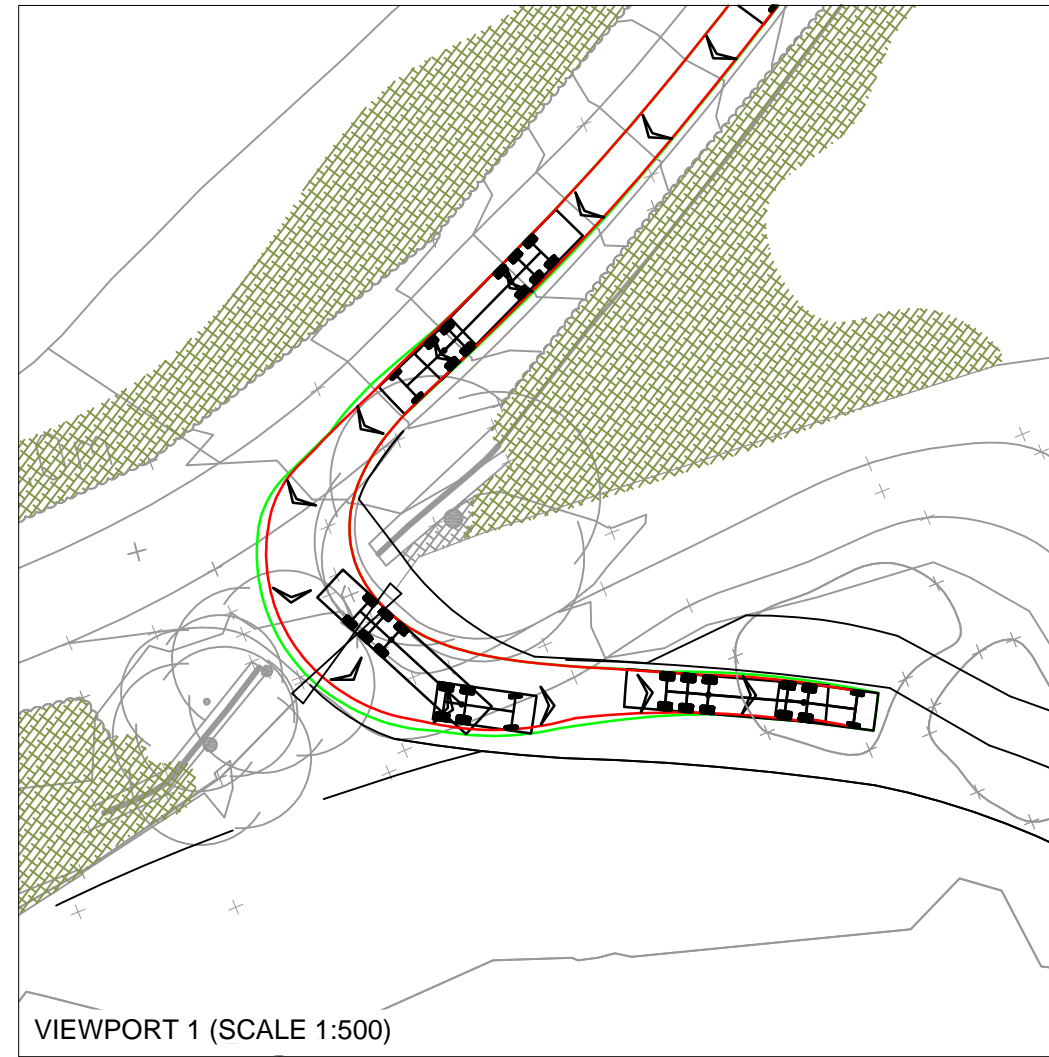

VEHICLE PROFILE

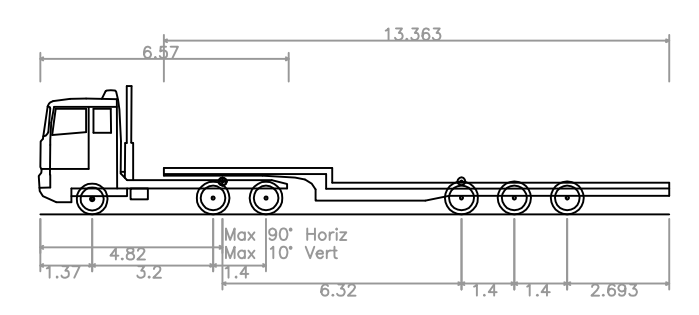

Low Loader
 Overall Length 16.633m
 Overall Width 2.500m
 Overall Body Height 3.396m
 Min Body Ground Clearance 0.320m
 Max Track Width 2.500m
 Lock to Lock Time 6.00s
 Kerb to Kerb Turning Radius 6.790m

VIEWPORT SCALE - 1:1250

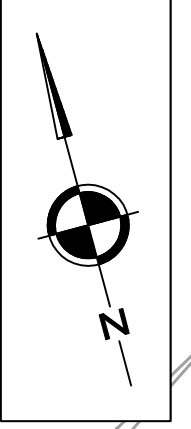
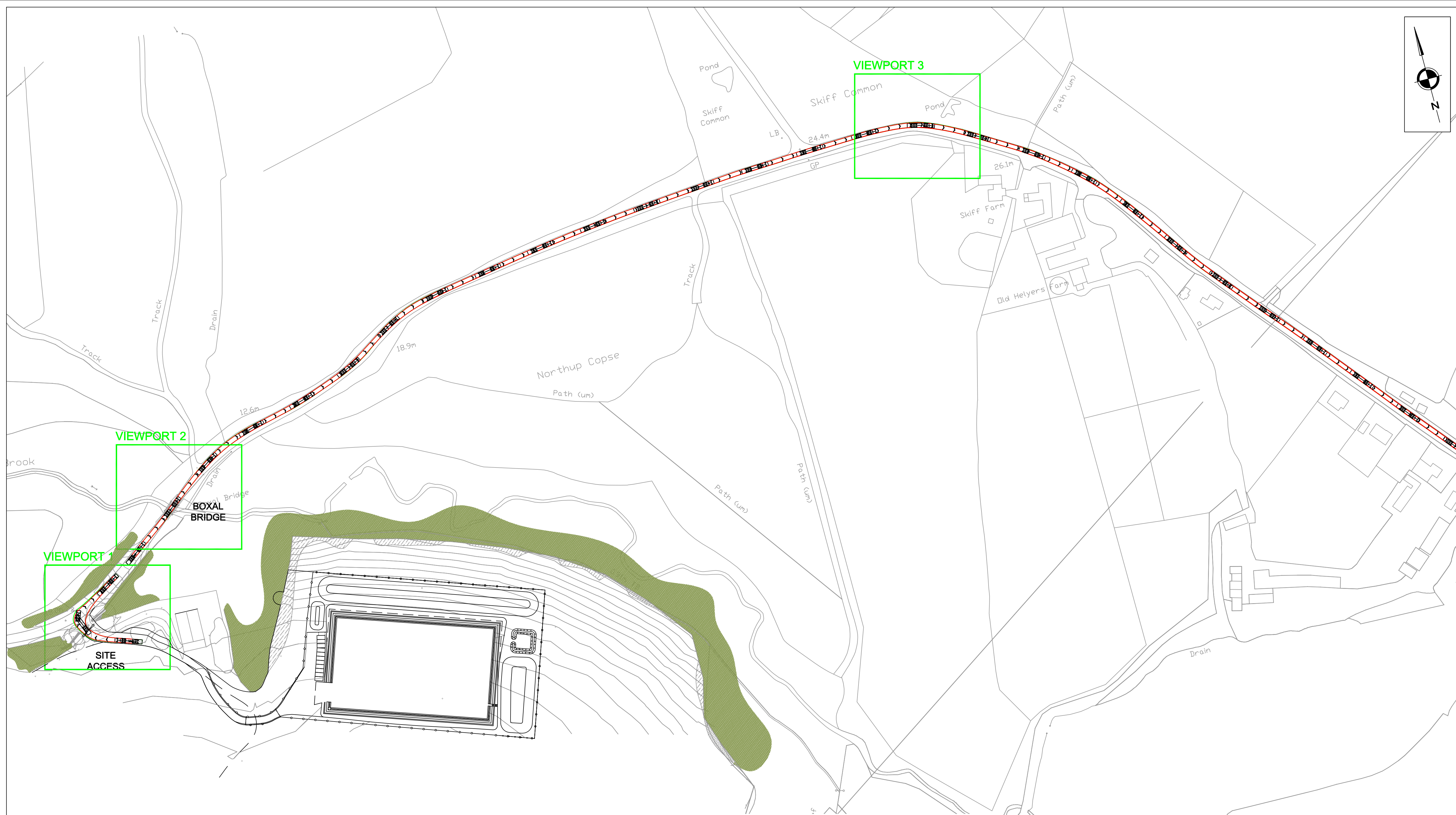

NOTES

REVISIONS

REV	DESCRIPTION	DATE	BY
-	-	-	-

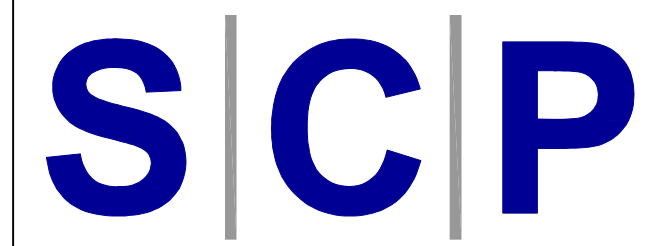

Transportation Planning : Infrastructure Design
 31 Southampton Row, London, WC1B 6HU, Tel 020 3376 6860
 www.scptransport.co.uk, Email info@scptransport.co.uk

Client Name:
 CELTIQUE ENERGIE WEALD LIMITED

Project Title:
 SOUTH DOWN CARBON EXPLORATION

Drawing Title:
 LOW LOADER ARTICULATED HGV
 SITE EGRESS ROUTE
 SWEEP PATH INFORMATION (SHEET1 OF 2)

Date: JULY 2014	Drawn By: IW
Scale: AS SHOWN @ A1	Checked: JR
Status: PLANNING	Approved: -

Drawing No: SCP/14809/SPA03 Rev: -

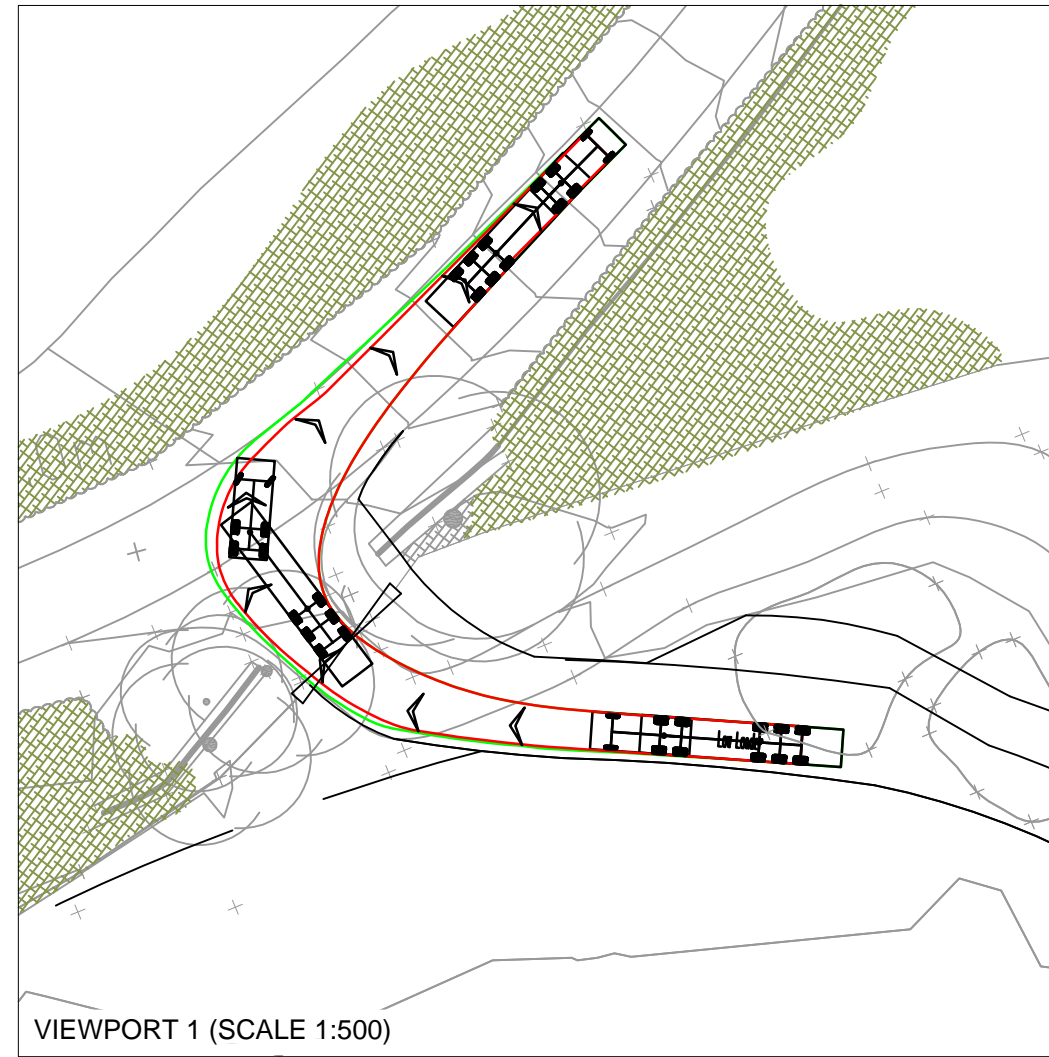

VIEWPORT 1 (SCALE 1:500)

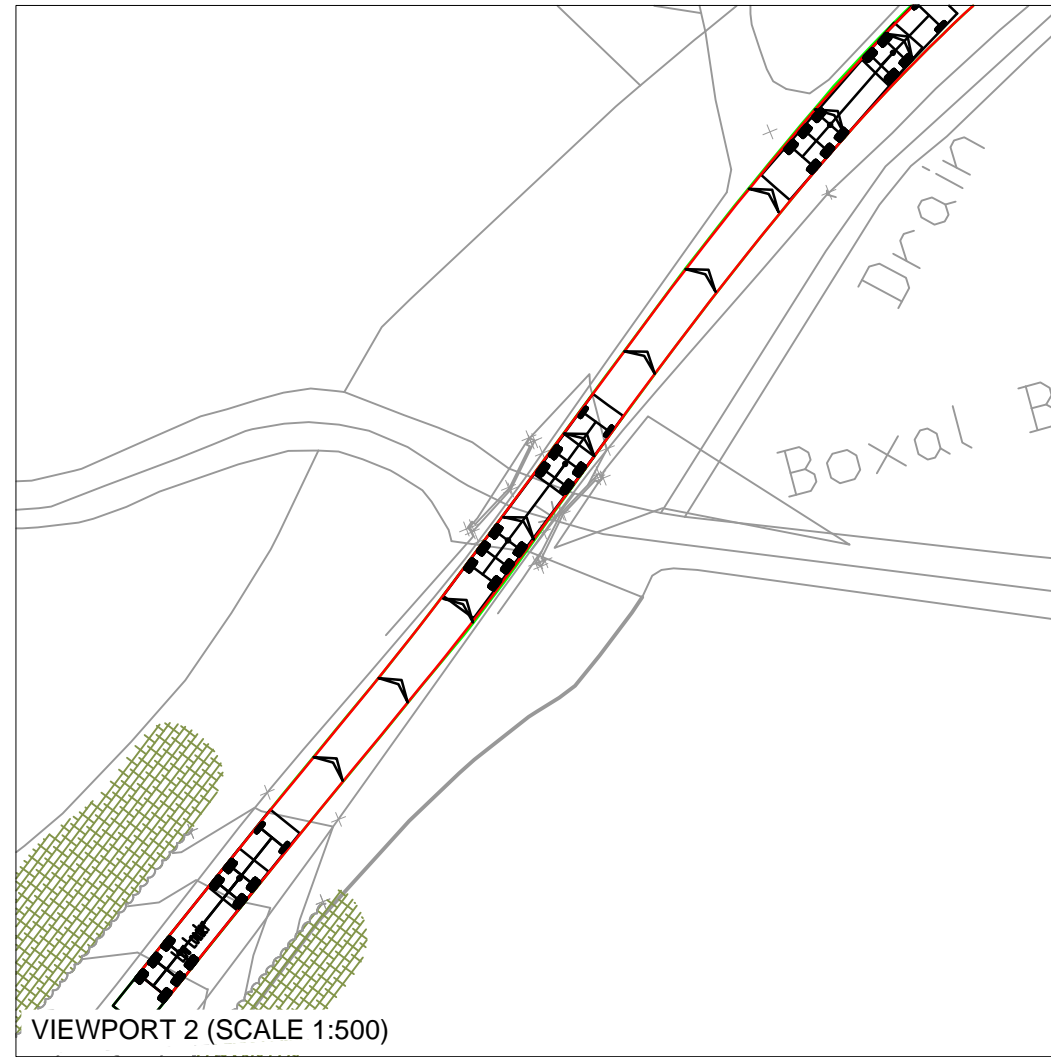

VIEWPORT 2 (SCALE 1:500)

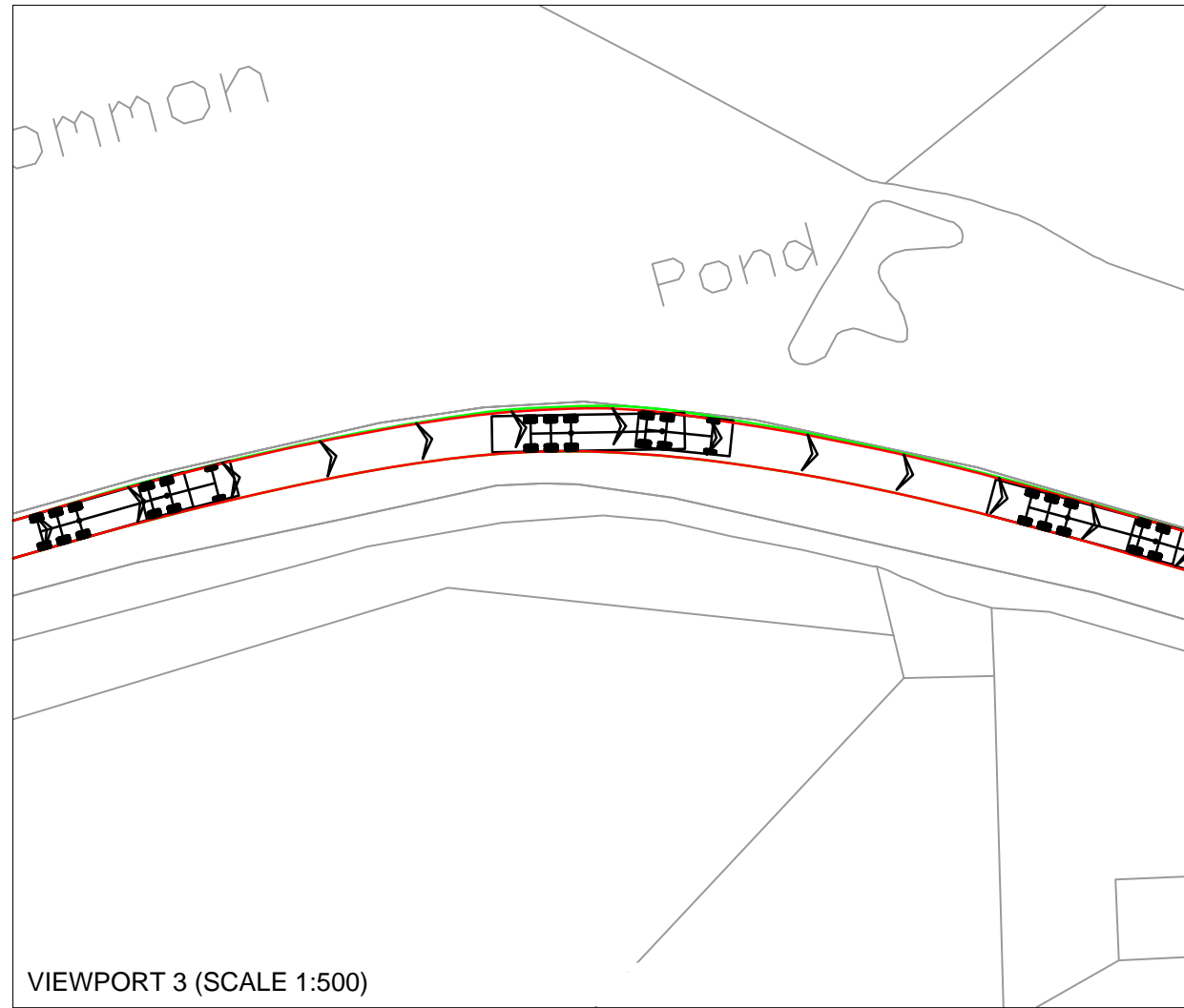

VIEWPORT 3 (SCALE 1:500)

VEHICLE PROFILE

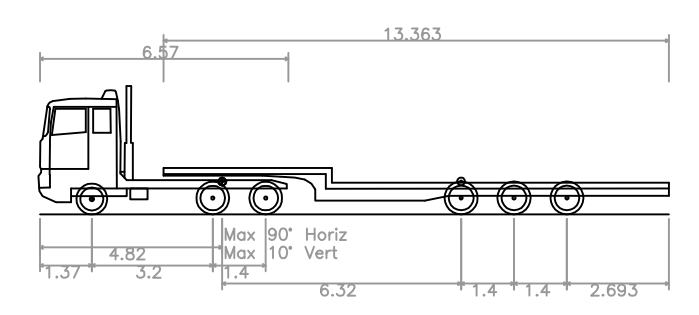

Low Loader
 Overall Length 16.633m
 Overall Width 2.500m
 Overall Body Height 3.396m
 Min Body Ground Clearance 0.320m
 Max Track Width 2.500m
 Lock to Lock Time 6.00s
 Kerb to Kerb Turning Radius 6.790m

VIEWPORT SCALE - 1:1250

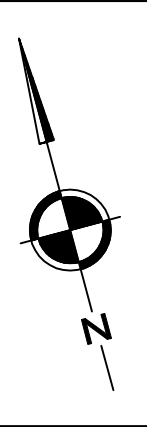

VEHICLE PROFILE

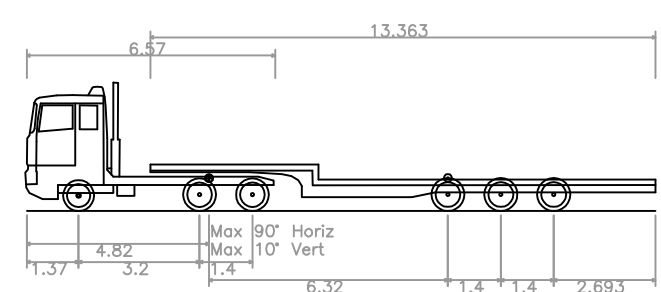

Low Loader
 Overall Length 16.633m
 Overall Width 2.500m
 Overall Body Height 3.396m
 Min Body Ground Clearance 0.320m
 Max Track Width 2.500m
 Lock to Lock Time 6.00s
 Kerb to Kerb Turning Radius 6.790m

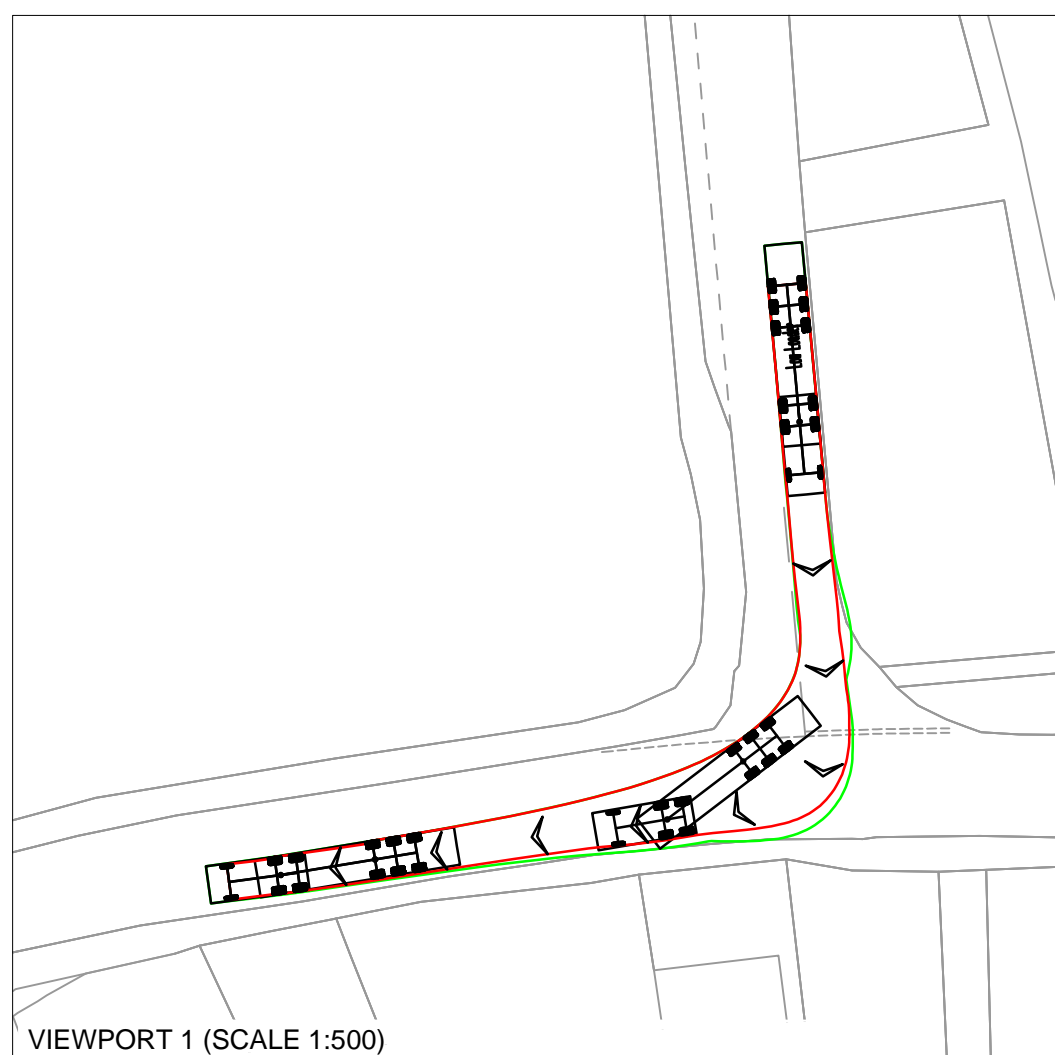

VIEWPORT 1 (SCALE 1:500)

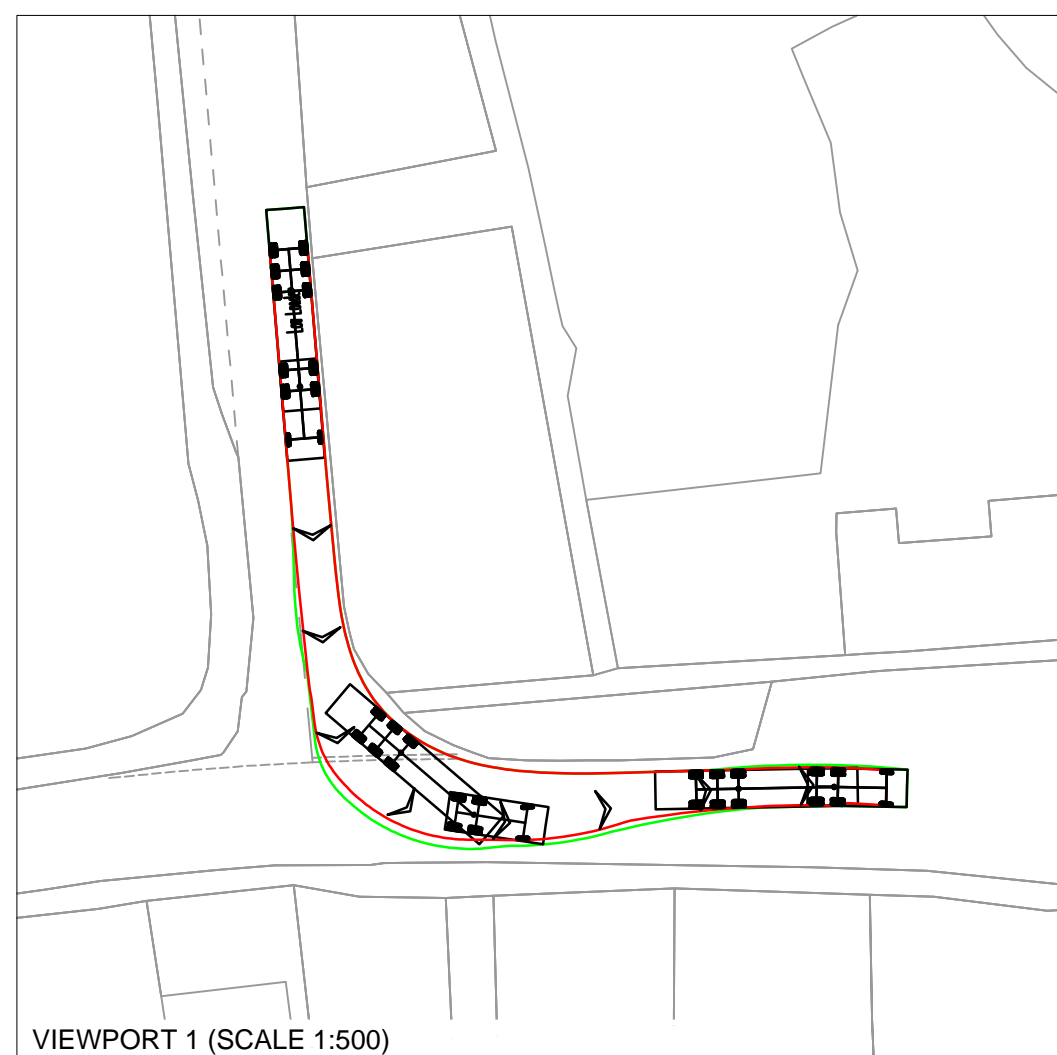

VIEWPORT 1 (SCALE 1:500)

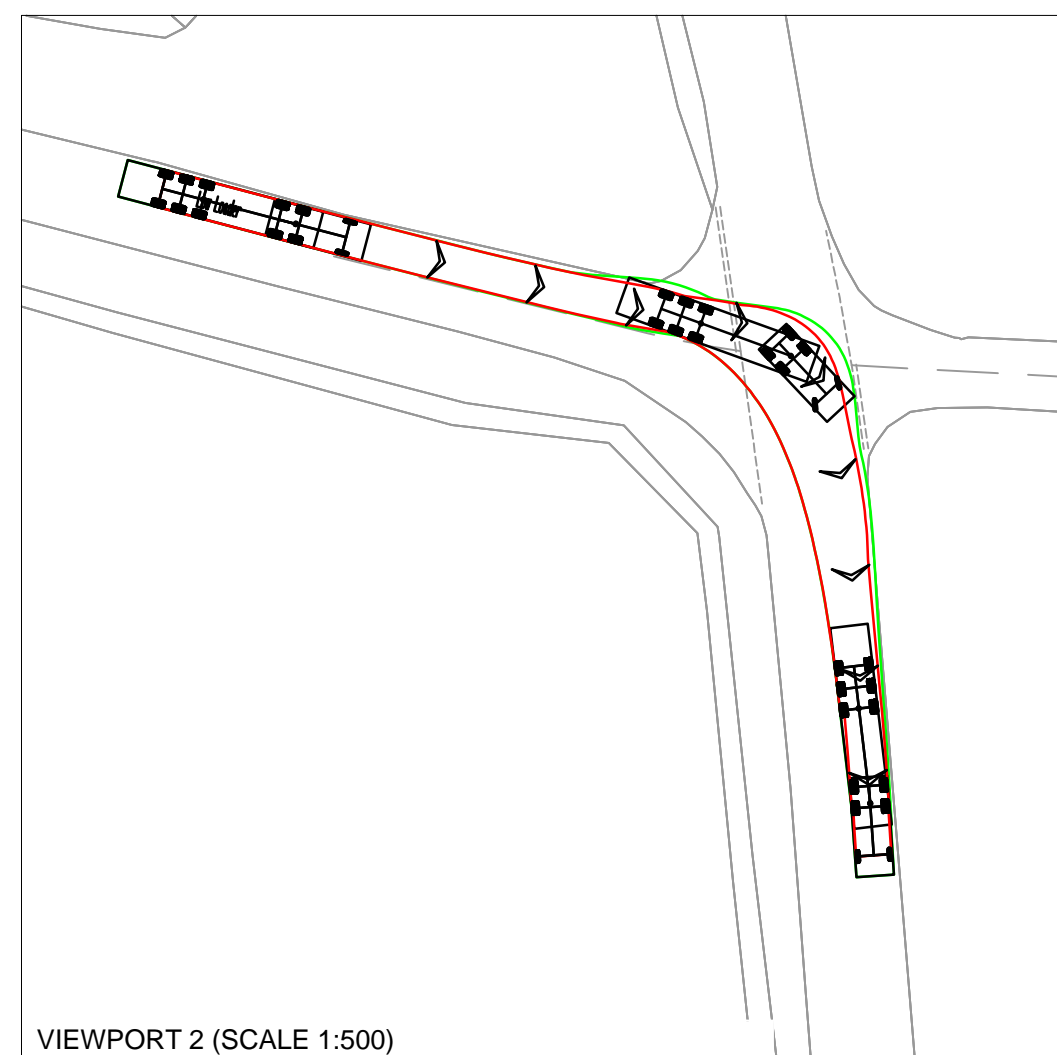

VIEWPORT 2 (SCALE 1:500)

VIEWPORT SCALE - 1:1250

NOTES

REVISIONS

REV	DESCRIPTION	DATE	BY
-	-	-	-

SCP

Transportation Planning : Infrastructure Design

31 Southampton Row, London, WC1B 6HU, Tel 020 3376 6660
www.scptransport.co.uk, Email info@scptransport.co.uk

Client Name:

CELTIQUE ENERGIE WEALD LIMITED

Project Title:

SOUTH DOWN CARBON EXPLORATION

Drawing Title:

LOW LOADER ARTICULATED HGV
SITE EGRESS ROUTE
SWEEP PATH INFORMATION (SHEET 2 OF 2)

Date: JULY 2014

Drawn By: IW

Scale: AS SHOWN @ A1

Checked: JR

Status: PLANNING

Approved: -

Drawing No: SCP/14809/SPA04

Rev: -