



APPENDIX 3.4 – ARBORICULTURE REPORT AND TREE PROTECT PLAN

Not updated



West Sussex County Council

A29 REALIGNMENT PHASE 1

Arboricultural Report

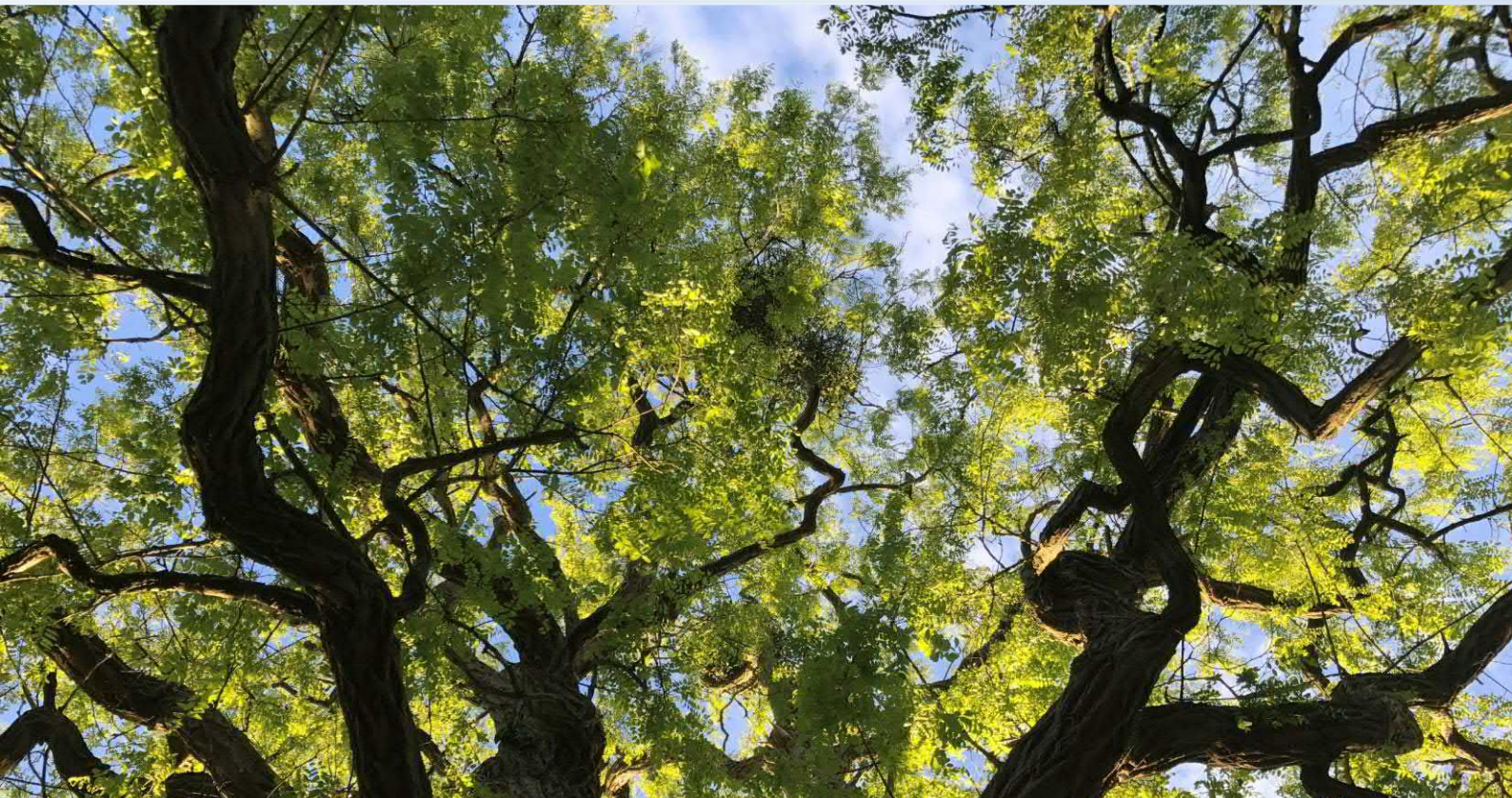



West Sussex County Council

A29 REALIGNMENT PHASE 1

Arboricultural Report

TYPE OF DOCUMENT (VERSION) PUBLIC

PROJECT NO. 70060779

OUR REF. NO. VERSION 2

DATE: OCTOBER 2020

WSP

1 Capital Quarter

Tyndall Street

Cardiff

CF10 4BZ

Phone: +44 2920 769 200

WSP.com



QUALITY CONTROL

Issue/revision	First issue	Revision 1	Revision 2	Revision 3
Remarks	Draft for review	WSCC comments addressed		
Date	August 2020	October 2020		
Prepared by	John Mitchener	John Mitchener		
Signature	-	Mitchener, John (john.mitchener) <small>Digitally signed by Mitchener, John (john.mitchener) DN: ou=Mitchener, John (john.mitchener), ou=Cardiff (1 Capital Quarter), email=john.mitchener@wsp.com Date: 2020.10.12 12:47:12 +01'00'</small>		
Checked by	Callum Throw	Callum Throw		
Signature	-	Throw, Callum (UKCTT002) <small>Digitally signed by Throw, Callum (UKCTT002) DN: cn=Throw, Callum (UKCTT002), ou=Birmingham (Mailbox), email=Callum.Throw@wsp.com Reason: I have reviewed this document Location: WSP Birmingham Mailbox Date: 2020.10.12 13:22:53 +01'00'</small>		
Authorised by	Jo North	Jo North		
Signature	-			
Project number	70060779	70060779		
Report number	Version 1	Version 2		

CONTENTS

1	INTRODUCTION	1
1.1	BACKGROUND	1
1.2	OVERVIEW OF THE PROPOSED PLANNING APPLICATION	1
1.3	SITE DESCRIPTION AND DESCRIPTION OF SCHEME	1
1.4	SCOPE OF REPORT	1
1.5	VALIDITY PERIOD	2
1.6	LIMITATIONS	2
1.7	RELEVANT LEGISLATION, POLICY AND GUIDANCE	2
2	BASELINE ARBORICULTURAL RESOURCE	4
2.1	BASELINE DATA COLLECTION	4
2.2	STUDY AREA	4
2.3	DESK STUDY	4
2.4	SITE VISIT / SURVEY	7
3	ARBORICULTURAL IMPACT ASSESSMENT	10
3.2	ARBORICULTURAL FEATURES TO BE REMOVED	10
3.3	OTHER ARBORICULTURAL IMPACTS	11
3.4	SEMI-NATURAL BUFFERS FOR VETERAN TREES	12
3.5	MITIGATION FOR REMOVED ARBORICULTURAL FEATURES	13
3.6	TREE PROTECTION PLAN	13
3.7	ARBORICULTURAL METHOD STATEMENT	14
4	SUMMARY AND CONCLUSIONS	15

TABLES

Table 2-1 - Arboricultural features covered by a TPO	5
Table 2-2 - Potential veteran trees	6
Table 2-3 - Summary of surveyed arboricultural features	7
Table 2-4 – Potential veteran trees	8
Table 3-1 - Arboricultural features to be removed sub-divided by type and quality	10
Table 3-3 – Other identified arboricultural impacts, proposed mitigation and likely effects	11
Table 3-4 – Encroachment into RPAs of retained trees	12

APPENDICES

APPENDIX A

GLOSSARY OF TERMS AND ACRONYMS

APPENDIX B

RELEVANT LEGISLATION, POLICY AND GUIDANCE

APPENDIX C

ARBORICULTURAL METHOD STATEMENT

APPENDIX D

ARBORICULTURAL SURVEY METHODOLOGY

APPENDIX E

ARBORICULTURAL SURVEY SCHEDULE

APPENDIX F

SUPPORTING DOCUMENTATION

APPENDIX G

TREE PROTECTION PLANS

1 INTRODUCTION

1.1 BACKGROUND

- 1.1.1. WSP has been instructed by West Sussex County Council to undertake a tree survey and to subsequently provide an Arboricultural Report in support of an Environmental Statement (ES). The ES is a supporting document in a planning application for the realignment of the A29 (referred to as the 'Scheme'), to the north of Eastergate, north-west of Barnham villages and north of Bognor Regis.
- 1.1.2. The purpose of this report is to identify all trees which may reasonably be affected by the Scheme, to assess the direct and indirect impact of the Scheme upon those trees and to recommend such protection measures as are necessary to ensure the long-term wellbeing of trees which are to be retained.

1.2 OVERVIEW OF THE PROPOSED PLANNING APPLICATION

- 1.2.1. The proposed planning application will seek permission for:
- The construction of a 1.25km single carriageway with a 3m wide shared cycleway / footway, four uncontrolled crossings, three roundabouts, landscaping, noise barrier and other associated works.*

1.3 SITE DESCRIPTION AND DESCRIPTION OF SCHEME

- 1.3.1. A detailed description of the Scheme location and surrounding area is provided within the **ES Chapter 2: The Existing Site**. Details on the Scheme are presented within the **ES Chapter 3: Description of the Scheme**.

1.4 SCOPE OF REPORT

- 1.4.1. The scope and level of detail included within this report is commensurate with that required for the adequate consideration of arboricultural features as part of a detailed planning application. Information provided complies with the requirements of British Standard BS 5837:2012 *Trees in relation to design, demolition and construction – Recommendations* (BS 5837) Table B.1 and includes reference to the following:
- Tree survey;
 - Arboricultural impact assessment;
 - Arboricultural method statement; and
 - Tree protection plan.
- 1.4.2. The BS 5837 'gives recommendations and guidance on the relationship between trees and the design, demolition and construction process. It sets out the principles and procedures to be applied to achieve a harmonious and sustainable relationship between trees and structures'¹.

■ ¹ British Standards Institute. 2012. *BS 5837: 2012 Trees in relation to design, demolition and construction – Recommendations*. London: BSI.

- 1.4.3. The BS 5837 does not provide explicit parameters for measuring the sensitivity of an arboricultural feature nor does it provide a methodology for the classification of effects. However, it does provide guidance on how to assess the quality of an arboricultural feature and further recommends an evaluation of impacts, both direct and indirect. Impacts should be defined as an assessment of arboricultural removals and identification of matters to be addressed within an arboricultural method statement.

1.5 VALIDITY PERIOD

- 1.5.1. Provisional Tree Preservation Orders (TPO) may be made whenever a local planning authority deems it appropriate with only those persons interested in the land served with a copy of the Order. Because of this, any reference to the presence of a TPO is only valid on the date at which the desk study search was undertaken. In instances where works unspecified in this report are to be undertaken, which may impact trees, a further search for the presence of TPOs should be carried out prior to commencement.
- 1.5.2. Trees are dynamic organisms which are influenced by a variety of environmental variables and whose health and condition can rapidly change. Any recommendations made within this report are valid for a period of 24 months from the date of survey, when any site conditions change or pruning or other works unspecified in the report are carried out to, or affecting, the subject trees, whichever is the sooner.

1.6 LIMITATIONS

- 1.6.1. This report in no way constitutes a health and safety survey. Where concerns for tree health and safety exist the necessary and appropriate tree inspections should be carried out.

1.7 RELEVANT LEGISLATION, POLICY AND GUIDANCE

- 1.7.1. This report has been compiled with reference to the following legislation, policy and guidance. Additional information relating to context and applicability is provided in **Appendix B**.

LEGISLATIVE FRAMEWORK

- *The Town and Country Planning Act 1990;*
- *The Town and Country Planning (Tree Preservation) (England) Regulations 2012;* and,
- *The Natural Environment and Rural Communities (NERC) Act 2006.*

POLICY

- *National Planning Policy Framework (NPPF) 2019²;* and,
- *Arun Local Plan 2011-2031 (adopted July 2018).*

² Ministry of Housing, Communities & Local Government (2019) *National Planning Policy Framework*. [Online] Available at <https://www.gov.uk/government/publications/national-planning-policy-framework--2> (Last accessed 12 August 2020)

GUIDANCE

- *British Standards Institute. BS 5837: 2012 Trees in relation to design, demolition and construction – Recommendations. London: BSI.;*
- *Arun Design Guide Supplementary Planning Document Final Draft 2020;*
- *Forestry Commission and Natural England, Ancient woodland, ancient trees and veteran trees: protecting them from development (2018)³;*
- *Ancient Tree Forum, Ancient and other veteran trees: further guidance on management (2013)⁴;*
- *Veteran Trees Initiative Specialist Survey Method (1997)⁵and,*
- *Ministry of Housing, Communities & Local Government, Tree Preservation Orders and trees in conservation areas (2014)⁶.*

³ Forestry Commission and Natural England (2018) *Ancient woodland, ancient trees and veteran trees: protecting them from development*. [Online] Available at <https://www.gov.uk/guidance/ancient-woodland-and-veteran-trees-protection-surveys-licences> (Last accessed 12 August 2020)

⁴ Lonsdale, D., 2013. *Ancient and other veteran trees: further guidance on management*. London: The Tree Council.

⁵ Fay, N. & de Berker, N., 1997. *Veteran Trees Initiative Specialist Survey Method*. Peterborough. Veteran Trees Initiative, English Nature.

⁶ Ministry of Housing, Communities & Local Government (2014) *Tree Preservation Orders and trees in conservation areas* [Online] Available at <https://www.gov.uk/guidance/tree-preservation-orders-and-trees-in-conservation-areas> (Last accessed 12 August 2020)

2 BASELINE ARBORICULTURAL RESOURCE

2.1 BASELINE DATA COLLECTION

2.1.1. Baseline data collection has been undertaken with reference to BS 5837 and has been undertaken using the following data sources:

- An arboricultural desk study, and
- A walkover survey of all arboricultural features within the study area.

2.1.2. Full details of the methodology used to obtain baseline data are provided in **Appendix D**.

2.2 STUDY AREA

2.2.1. A study area comprising of the Planning Application Site Boundary and a 50-metre buffer has been utilised for the arboricultural desk study. The purpose of this buffer is to facilitate the identification of ancient and veteran trees whose protection may require the provision of a semi-natural buffer zone with a minimum uncapped radius extending to five metres beyond the canopy or up to 15 times the stem diameter, whichever is greater. As such, semi-natural buffer zones may extend for tens of metres.

2.2.2. A study area comprising of the Planning Application Site Boundary and a 15-metre buffer has been utilised for the walk over survey. The purpose of this buffer is to ensure compliance with BS 5837 which recommends that all trees whose root protection areas (RPAs) extends into the developable area are identified and surveyed. The BS 5837 caps RPAs with a maximum radius of 15-metres. In instances where ancient and veteran trees have been identified outside this area then they have been surveyed in order to enable semi-natural buffer zones to be correctly calculated.

2.3 DESK STUDY

2.3.1. The arboricultural desk study confirmed the absence of any conservation areas within the study area. It further identified the absence of any recorded ancient woodland or ancient trees.

2.3.2. The desk study did however identify the presence of a single Tree Preservation Order whilst also identifying records of two of potential veteran trees.

TREE PRESERVATION ORDERS

2.3.3. Individual trees, groups of trees or areas of woodland may be afforded statutory protection through inclusion within a Tree Preservation Order (TPO). The legislation governing TPOs is included within Part VIII of the Town and Country Planning Act 1990 as amended by the Town and Country Planning (Tree Preservation) (England) Regulations 2012.

2.3.4. A TPO may be made by a local planning authority where it is believed '*that it is expedient in the interests of amenity to make provision for the preservation of trees or woodlands*'⁷. Subject to certain exemptions, a TPO makes it a statutory offence to cut down, uproot, lop, top, wilfully damage or wilfully destroy a protected tree without formal consent.

⁷ *Town and Country Planning Act 1990*. s.198(1).

2.3.5. The arboricultural features listed in **Table 2-1** are located within the study area and have been identified as being afforded statutory protection by virtue of TPO BN/1/20. This Order, administered by Arun District Council, is shown as an irregularly shaped polygon on the Council’s online mapping service⁸. However, more detailed maps provided by the Council on 13 May 2020 indicate an intention to protect specific trees and groups of trees. A copy of the more detailed maps showing the location of individual protected features are included within **Appendix F** of this report.

Table 2-1 - Arboricultural features covered by a TPO

Reference number on 1 st Schedule ⁹ TPO	Species	TPO Name	Location
T7	Pedunculate oak (<i>Quercus robur</i>)	TPO BN/1/20	Land north of Barnham Road, Eastergate, West Sussex PO20 3SJ
T8			
T9			
T10			
T11			
T12			
T15			
T16			
T17			
T18			
T20			
T21			
T22			
T27			

⁸ Arun District Council, 2020. *Arun Maps* [online] Available at: <https://www1.arun.gov.uk/webapps/wml/> [Accessed 17 August 2020].

⁹ The first schedule forms part of the TPO document and includes a written description of the trees and their location. Within the 1st Schedule the following abbreviations are used:

- T – individual tree
- G – group of trees
- W – woodland
- A – area of trees

T28			
T29			
T30			
T31			
T32			
G37	Hornbeam (<i>Carpinus betulus</i>)		

2.3.6. A total of 19 trees and one tree group have been identified as being afforded protection by virtue of TPO BN/1/20. All of the individual trees are pedunculate oak whilst tree group G37 is recorded as comprising of a number of hornbeam. Features protected by TPO BN/1/20 are located towards the northernmost extent of the Scheme and on land east of Fontwell Avenue and south of Eastergate Lane. The location of these TPO features is shown on the Tree Protection Plan included in **Appendix G**.

VETERAN TREES

2.3.7. The National Planning Policy Framework (NPPF) defines ancient and veteran trees as ‘A tree which, because of its age, size and condition, is of exceptional biodiversity, cultural or heritage value. All ancient trees are veteran trees. Not all veteran trees are old enough to be ancient but are old relative to other trees of the same species. Very few trees of any species reach the ancient life-stage.’

2.3.8. The desk study identified the individual trees listed in **Table 2-2** as being potential veteran specimens.

Table 2-2 - Potential veteran trees

Tree id. (Ancient Tree Inventory)	Species	Status	Recorded girth of stem (m)
97690	Pedunculate oak	Veteran	7.6m at a height of 0.5 metres
97691	Pedunculate oak	Veteran	4.8 at a height of 1.5 metres

2.3.9. By virtue of the definition provided within the NPPF, ancient and veteran trees may be described as those with exceptional biodiversity, cultural or heritage value. Given that veteran trees are of a lesser age than ancient specimens, their main value is likely to lie with the provision of biodiversity rather than being associated with culture or heritage.

2.3.10. Trees 97690 and 97691 are ‘potential’ veteran trees on the basis that their ability to provide exceptional biodiversity remains unknown. As described in the Veteran Trees Initiative Specialist Survey Method (SSM) (Fay and de Burke, 1997) the identification of veteran trees can involve varying levels of technical inspection with only the most comprehensive capable of definitively identifying not just habitat quality but also the species that it supports.

- 2.3.11. In the interests of this assessment, for a tree to be defined as truly veteran, evidence should be available which not only demonstrates that entomological, mycological, floral and faunal surveys have been completed but that it also supports, or is capable of supporting, a diversity of insects, fungi and plants. This level of detail is absent from the desk study data.
- 2.3.12. Potential veteran trees 97690 and 97691 are located on the eastern side of public footpath 318 and towards its northern end. Their positions are identified within the Tree Protection Plan included in **Appendix G**.

2.4 SITE VISIT / SURVEY

- 2.4.1. A total of 77 arboricultural features were surveyed details of which are provided within the Arboricultural Survey Schedule included in **Appendix E** of this report. Their location and extent are shown on the Tree Protection Plan included in **Appendix G**. A summary of the surveyed features including their category and designation is provided in **Table 2-3**.

Table 2-3 - Summary of surveyed arboricultural features

BS 5837 Category	Quality	Trees	Tree Group	Hedges
A	High	8	0	0
B	Moderate	7	2	0
C	Low	31	23	6
TOTAL		46	25	6

POTENTIAL VETERAN TREES

- 2.4.2. The walkover survey identified the presence of four veteran trees. These include confirmation of two potential veterans identified during the desk study as well as the identification of two previously unknown specimens.
- 2.4.3. The presence of the two potential veteran oak trees identified during the desk study was confirmed during the course of the walkover survey at which point they were recorded as trees T2 (97691) and T20 (97690).
- 2.4.4. Two additional potential veteran trees were also identified. These are also both oak trees and are located in close proximity to each other within a small treed area to the north of the Planning Application Site Boundary and to the south of Eastergate Lane. These trees are recorded as T23 and T42 within the Arboricultural Survey Schedule.
- 2.4.5. Veteran trees have been identified on the basis of age and size. They are all mature specimens with stem diameters ranging from 1300 to 1900 millimetres. Stem diameters of this size are indicative of aging trees and include a sufficient volume of wood for them to potentially provide irreplaceable deadwood habitat. Veteran trees have not been subject to detailed entomological, mycological, floral or faunal surveys and as such their status should remain provisional until such time as the presence of exceptional biodiversity value is confirmed. Nonetheless, regardless of habitat value, these trees still represent particularly good examples of rural oaks which have potentially taken several centuries to develop. They are therefore high-quality (category A) trees worthy of retention.

2.4.6. All four potential veteran trees are afforded protection by virtue of TPO/BN/1/20. A summary of their statutory status is provided in **Table 2-4**. The fact that these trees are protected by a TPO is indicative of the high level of current and future public amenity value which Arun District Council consider them to possess.

Table 2-4 – Potential veteran trees

Reference number (Arboricultural Survey Schedule)	Reference number on 1 st Schedule TPO	TPO Name
T2	T29	TPO/BN/1/20
T20	T27	
T23	T18	
T42	T42	

OTHER HIGH QUALITY ARBORICULTURAL FEATURES

- 2.4.7. Other high-quality features include three pedunculate oaks (T3, T10 and T25) and one evergreen oak (*Quercus ilex*) (T45). Trees T3 and T25 are located to the north of the Planning Application Site Boundary and south of Eastergate Road whilst T10 is positioned within the front garden of a residential property west of the A29 Fontwell Avenue. Evergreen oak T45 is also located within the front garden of a residential property to the north of the B2233 Barnham Road.
- 2.4.8. All four high-quality trees are mature specimens with heights of 15 to 20 metres, stem diameters ranging from 740 millimetres to 1300 millimetres and retention spans in excess of 40 years under current site conditions. They have been variously valued based upon their arboricultural and landscape merits.
- 2.4.9. High-quality trees T3, T10, T25 and T45 represent good examples of their species and positively contribute to the character of the local landscape. Trees T3 and T25 are afforded statutory protection by virtue of TPO/BN/1/20 and are recorded within the Order as T15 and T16 respectively.

MODERATE QUALITY ARBORICULTURAL FEATURES

2.4.10. A total of nine moderate quality arboricultural features were recorded and include seven individual trees and two tree groups.

Individual Trees

- 2.4.11. Of the seven individual trees, four are pedunculate oak, two are evergreen oak and one is a poplar (*Populus sp.*). Again, all are mature specimens and have heights of ten to 18 metres, stem diameters ranging from 350 millimetres to 860 millimetres and retention spans in excess of 20 years under current site conditions. They have been variously valued based upon their landscape merits.
- 2.4.12. Moderate-quality trees are recorded as T5, T7, T11, T39, T40, T50 and T55 and are scattered around the northern and southern ends of the Planning Application Site Boundary. These are specimens which lack the special value associated with high-quality features, but which nonetheless still provide a quantifiable degree of amenity value. This value is reflected in the fact that trees T11 and T39 are included within TPO/BN/1/20 and are respectively recorded as T31 and T8.

Tree Groups

- 2.4.13. Two moderate-quality tree groups were identified and are recorded as G71 and G85. These two groups are located within, or adjacent to, the northern portion of the Planning Application Site Boundary and predominately comprise Lombardy poplar (*Populus nigra 'Italica'*) (G71) and hornbeam (*Carpinus betulus*) (G85).
- 2.4.14. Moderate-quality tree groups include trees with heights of 12 to 17 metres, stem diameters of 350 to 850 millimetres and collective retention spans in excess of 20 years. They have been valued based upon their visual amenity and contribution to the character of the local landscape.
- 2.4.15. Tree-group G85 is included within TPO/BN/1/20 where it is recorded as 'G37'.

LOW QUALITY ARBORICULTURAL FEATURES

- 2.4.16. The walkover survey identified 60 low quality features including 31 trees, 23 tree groups and six hedges. Low quality features are formed from a range of predominately native or naturalised tree species including apple (*Malus domestica*), ash (*Fraxinus excelsior*), oak, blackthorn (*Prunus spinosa*), hawthorn (*Crataegus monogyna*), field maple (*Acer campestre*), holly (*Ilex aquifolium*) and beech (*Fagus sylvatica*). Some ornamental species such as Norway maple (*Acer platanoides*) and Lawson cypress (*Chamaecyparis lawsoniana*) are also present.
- 2.4.17. Low quality trees, tree groups and hedges range in age from young to mature, have heights of two to 16 metres, stem diameters ranging from 75 millimetres to 800 millimetres and retention spans in excess of 10 years under current site conditions. They have been valued mainly for their localised visual amenity and limited contribution to the wider landscape.
- 2.4.18. Low-quality tree group G98 includes apple trees which appear to represent the remnants of an old commercial orchard. The variety of apple tree is unknown but may represent one which is no longer commercially available, and which may be rare or of particular local significance. Therefore, although the individual apple trees which form part of G98 may be individually of little value, their propagation may have benefits from an historic and genetic diversity perspective.
- 2.4.19. Low-quality features are located across the length of the Planning Application Site Boundary. They represent features with only minimal or temporary landscape and visual benefits, and none are afforded statutory protection.

UN-SURVEYED FEATURES

- 2.4.20. There are two un-surveyed arboricultural features present within, or adjacent to, the Planning Application Site Boundary. Access to the land within which these features are located was not available at the time of the walkover survey and as such they could not be surveyed.
- 2.4.21. Un-surveyed features are located at the southernmost end of the Planning Application Site Boundary and around the edge of a piece of land used for glasshouse production. Aerial imagery indicated that these two features are formed from maintained hedgerows. It is considered likely that they are low-quality features offering only low-level and localised screening value.

3 ARBORICULTURAL IMPACT ASSESSMENT

3.1.1. The following Arboricultural Impact Assessment (AIA) evaluates the direct and indirect effects associated with construction of the Scheme on existing trees. It further identifies necessary mitigation measures where these are deemed appropriate.

ASSUMPTIONS AND LIMITATIONS

3.1.2. This AIA has been compiled on the basis of the following assumptions and limitations:

Assumptions

- That all construction activities will be confined to the area within the Planning Application Site Boundary;
- That the area to the rear of the proposed tree protection fencing is defined as ‘an area within which the maximum feasible amount of vegetation will be retained where possible’; and,
- That suitable site fencing will be established around the entirety of the Planning Application Site Boundary.

Limitations

- The contractors spatial working requirements remain unknown; and,
- Enabling works (such as the diversion of services by statutory undertakers) have not been considered.

3.2 ARBORICULTURAL FEATURES TO BE REMOVED

3.2.1. Arboricultural features selected for removal are clearly identified on the Tree Protection Plan (TPP) included in **Appendix G** of this report. Details of the arboricultural features to be removed are summarised in **Table 3-1**.

Table 3-1 - Arboricultural features to be removed sub-divided by type and quality

BS 5837 Category	Quality	Trees	Tree Group	Hedges
B	Moderate	0	1 (part removed)	0
C	Low	22	14 (12 part removed)	4 (2 part removed)
TOTAL		22	15	4

3.2.2. Construction of the Scheme will require the removal of 22 individual trees and the whole or partial removal of 15 tree groups and four hedges. Trees to be removed are all of low-quality and include T1, T6, T12, T14-T19, T21, T24, T26, T31, T33, T34, T51, T52, T54, T57, T58, T63 and T64. Low-quality tree groups G65 and G86 as well as low-quality hedges H66 and H78 will also be completely removed.

3.2.3. A total of 13 tree groups and two hedges will also be partially removed. These include moderate quality tree group G85, low-quality tree groups G73, G74, G76, G82, G88, G93, G95-G98, G104 and G107. Also identified for partial removal are low-quality hedges H75 and H83.

- 3.2.4. In addition to the 22 individual trees which are to be lost, the total removals equate to approximately 192 linear metres of tree groups, 165 linear metres of hedge and 0.7 hectares of tree cover (groups). With the exception of 36 linear metres of moderate-quality tree group G85, all other losses relate solely to low-quality features.
- 3.2.5. Arboricultural removals have been identified on the basis that they are either located directly within the area of construction or that their RPAs cannot be protected such that they can be sustainably retained. Removals have not been specified in areas where construction access can reasonably be excluded or where RPAs can be adequately protected.
- 3.2.6. Moderate-quality tree group G85 is covered by TPO/BN/1/20. This means that a number of protected trees will need to be removed in order to facilitate construction. The trees to be removed are those located at the northernmost end of the group and represent only a small percentage of all protected trees. The removal of these trees will not result in a significant loss of public amenity or landscape value nor will they significantly reduce the visual amenity of the overall tree group. The proposed tree losses can therefore be tolerated without leading to a devaluation of the TPO.
- 3.2.7. An 18-metre-long line of un-surveyed trees has also been identified for possible removal. These trees located at the southernmost end of the Scheme and their removal will be required should access be required to land outside the Planning Application Site Boundary. It is assumed that the line of trees which may require removal are all of low-quality and of little visual value.
- 3.2.8. With the exception of G85, construction of the Scheme will not require the removal of any moderate or high-quality feature covered by a TPO or any tree identified as having veteran potential.

3.3 OTHER ARBORICULTURAL IMPACTS

- 3.3.1. Other identified arboricultural impacts associated with the construction of the Scheme are recorded in **Table 3-2**. Other arboricultural impacts are defined as identified activities which have the capacity, if uncontrolled, to cause damage to arboricultural features which are to be retained.
- 3.3.2. **Table 3-2** provides details of the arboricultural features which are at risk of damage, the likely cause of damage and the mitigatory measures which are required. Implementation of the recommended mitigatory measures will be sufficient to ensure that arboricultural features can be retained without significant loss of value or a notable reduction in health or longevity.

Table 3-2 – Other identified arboricultural impacts, proposed mitigation and likely effects

Feature	Cause of Impact (construction of)	Potential Impact	Mitigatory Measures
G98 (TPO tree T9)	Construction access within RPA.	Soil compaction and root damage. Loss of vitality and decline in health Reduction in quality of tree / potential death of tree.	Installation of tree protection fencing to protect as much of RPA as possible. Formation of a protected area which is sufficiently large to compensate for any encroachment into the RPA.
G98 (TPO tree T22)			
T25			
T39			

Feature	Cause of Impact (construction of)	Potential Impact	Mitigatory Measures
All other retained trees whose RPA extends across the Planning Application Site Boundary.			Installation of tree protection fencing to protect RPA.

3.3.3. Identified arboricultural impacts include two TPO trees which form part of tree group G98. These trees referenced as 'T9' and 'T22' within the Order, were not individually recorded during the walkover survey and as such are not included within the Arboricultural Survey Schedule. Their locations were however apparent on the topographical survey which also included data on the height, crown spread and stem diameter. Root protection areas for T9 and T22 have therefore been calculated using topographical survey data and are estimated to have a radius of 6.9 and ten metres respectively.

3.3.4. Identified arboricultural impacts include a requirement for construction access within the RPAs of trees T9, T22, T25 and T39. Access is required in order to ensure that construction can take place. Construction access will be limited by the installation of tree protection fencing as specified within the TPP. Subject to installation of protective fencing, encroachment into the RPAs of trees T9, T22, T25 and T39 will be in accordance with the details provided in **Table 3-3**. Encroachments range from 2% for T22 to 15% for T39. These levels of encroachment are believed to be acceptable on the basis that they will only occur on one side of the RPA, are unlikely to impact the tree's structural rootplate and can be offset by the availability of compensatory rooting volume contiguous with the remainder of the RPA. Construction access should not result in the loss, or degradation, of these four trees.

Table 3-3 – Encroachment into RPAs of retained trees

Feature	RPA Area (m ²)	Area of RPA to be lost (m ²)	Percentage of RPA to be lost
T9	111	7	6.3
T22	341	7	2.0
T25	652	49	7.5
T39	228	34	15.0

3.3.5. Arboricultural features G71, G74, G76, G78, G81, G85, G91, G97, G98, G104, G107, H69, H75, H84, T2, T3, T7, T9, T22, T25, T39, T40, T41, T44-T46, T50, T55 and T59 all have RPAs which extend into the Planning Application Site Boundary. The RPAs of these features can be fully protected through the use of tree protection fencing as specified in the TPP. These features will therefore remain unaffected during construction.

3.4 SEMI-NATURAL BUFFERS FOR VETERAN TREES

3.4.1. Standing advice from the Forestry Commission and Natural England recommends that a semi-natural buffer be maintained between veteran trees and any development. This semi-natural buffer

should be calculated as 15 x stem diameter or five metres beyond the tree's canopy, whichever is greater.

- 3.4.2. Semi-natural buffers of 15 x stem diameter have been applied in respect of potential veteran trees T2, T20, T23 and T42. These buffers are shown on the TPP included in **Appendix G**. In each instance these semi-natural buffers can be wholly retained during construction and can be robustly protected through the appropriate use of tree protection fencing.

3.5 MITIGATION FOR REMOVED ARBORICULTURAL FEATURES

- 3.5.1. Mitigation for the loss of trees, tree groups and hedges will occur as part of the post-development soft landscaping scheme. This scheme includes the planting of woodland areas, specimen trees, shrubs and hedges. These landscaping elements have been designed to fully integrate into the Scheme and will provide sustainable and high-quality replacements for arboricultural features which have been identified as needing to be removed.

3.6 TREE PROTECTION PLAN

- 3.6.1. A Tree Protection Plan (TPP) is included within **Appendix G** of this report. The purpose of the TPP is to identify trees for retention and show the location and extent of any proposed tree protection measures.
- 3.6.2. The TPP has been compiled in accordance with the following specification:

General

- The TPP shows the position of each feature including its stem/extent, current crown spread and its root protection area. The features have also been coloured based upon the quality category within which they have been placed.

Location / extent of arboricultural features

- Arboricultural features have been located using topographical survey data where stem locations have been provided. In instances where topographical data is unavailable then features have been positioned using Ordnance survey data and/or aerial imagery. In these instances, locations should be considered as approximate only and will have an assumed accuracy of two to five metres.

Root Protection Areas (RPA)

- The shape of the RPA shown on the TPP have been modified where barriers to root growth have been identified. For the purposes of this report barriers are defined as any feature with a substantive foundation or which would obviously form a relatively impenetrable barrier to root growth.
- Barriers to root growth have been identified on the basis that in a typical instance approximately 90% of roots occur in the upper one metre of soil¹⁰. Barriers do not have to prevent all root growth but simply restrict it sufficiently that the area beyond the barrier is unlikely to be critical to maintaining the vitality of the arboricultural feature. Structures such buildings and roads have

¹⁰ Roberts, J., Jackson, N., Smith, M., 2006. *Tree Roots in the Built Environment*. London: The Stationary Office

been identified as likely to have substantive foundations such that they will limit/prevent substantive root growth.

Tree protection measures

- The TPP shows the location and extent of the following tree protection information:
 - Tree retention and removals (RPAs shown for all retained trees)
 - Tree Protection Fencing

3.7 ARBORICULTURAL METHOD STATEMENT

3.7.1. The Arboricultural Method Statement (AMS) provided within **Appendix G** adopts a precautionary approach to tree protection and addresses all activities which have the potential to cause damage to retained trees. For the purposes of the Scheme this includes reference to the following matters:

- Arboricultural monitoring
- Protective barriers

3.7.2. It is envisaged that the AMS will be reviewed by the design team during the detailed design phase. The review will include a re-assessment of likely impacts and proposed mitigation. It is envisaged that the AMS will be subsequently amended to reflect any changes and to add additional detail in instances where this is required. Matters which are likely to require consideration or updating include the following:

- The phasing of site clearance and construction activities and tree protection measures;
- Arboricultural monitoring and site supervision;
- The location and specification for protective barriers. (Tree protection barriers should be erected prior to any site clearance or construction activities and should remain insitu throughout the construction process. The area to the rear of the protective barriers must be designated as a construction exclusion zone and is an area where all site clearance and construction activities are prohibited);
- The design and construction of boundary fencing;
- The design and construction of surface water drains, ditches and ancillary structures;
- The design and construction of underground services and ducts;
- The design and construction of any structure within the RPA of any retained tree. These should include footpaths, stiles, gates and boundary fencing; and,
- The tree protection measures and working methodology to be applied to soft landscaping activities within the RPA of retained trees.

3.7.3. The AMS must be read in conjunction with the Construction Environmental Management Plan, the Tree Protection Plan and all relevant design drawings, specifications and method statements.

3.7.4. The AMS should be viewed as a 'live' document and should be subject to regular review prior to and during construction.

4 SUMMARY AND CONCLUSIONS

- 4.1.1. A desk study was undertaken on land within the Planning Application Site Boundary plus a 50-metre buffer. The desk study revealed the presence of two recorded veteran trees and a single Tree Preservation Order (TPO). The TPO is titled TPO/BN/1/20 and protects 19 individual trees and one tree group.
- 4.1.2. A walkover survey was undertaken on land within the Planning Application Site Boundary plus a 15-metre buffer. This buffer was extended to 50 metres in respect of any potentially veteran trees. The walkover survey identified the presence of 77 arboricultural features including 46 trees, 25 tree groups and six hedges. The surveyed arboricultural features include eight high-quality trees and seven moderate-quality trees and two tree groups. They also include 31 low-quality trees, 25 tree groups and six hedges.
- 4.1.3. Four potentially veteran trees were identified. These include the two that were recorded during the desk study and two previously unknown specimens.
- 4.1.4. At the time of the walkover survey, access was not available on land to the southern end of the Planning Application Site Boundary. Aerial imagery indicates the presence of two maintained hedgerows within this area records of which are absent from the Arboricultural Survey Schedule. Both hedgerows are considered as likely to be low-quality features.
- 4.1.5. An Arboricultural Impact Assessment (AMS) has been undertaken. This assessment indicates that construction of the Scheme is likely to require the whole or partial removal of 22 individual trees, 15 tree groups and four hedges. With the exception of the partial removal of moderate-quality tree group G85 removals will be restricted to low-quality features and will include 22 individual trees, 156 linear metres of tree group, 165 linear metres of hedge and 0.7 hectares of tree cover (groups). It is considered likely that an additional 18-metre-long section of low-quality un-surveyed trees may also be removed at the southernmost extent of the Scheme.
- 4.1.6. Thirty-six linear metres of tree group G85 will be removed. This tree group is of moderate quality and is also covered by TPO/BN/1/20. Removals are limited to a short section at its northernmost end and are insufficient to have a significant adverse impact on the visual amenity value of the feature as a whole. The value of G85 as a protected tree group will therefore not be significantly devalued.
- 4.1.7. With the exception of G85 arboricultural removals do not include any high or moderate quality features, any feature covered by TPO/BN/1/20 or any potentially veteran trees.
- 4.1.8. Other identified arboricultural impacts include the potential for construction access to occur within the Root Protection Areas (RPAs) of retained trees. These impacts can be successfully mitigated through the use of tree protection fencing as specified in the Arboricultural Method Statement (AMS) and Tree Protection Plan (TPP). In four instances RPAs cannot be fully protected with protective fencing. However, in each instance the level of encroachment is sufficiently low for trees to be sustainably retained. Other arboricultural impacts will therefore not put any arboricultural feature at risk of removal nor will they result in arboricultural features becoming unsustainable over the longer-term.

- 4.1.9. Semi-natural buffers have been applied to veteran trees in accordance with standing advice from the Forestry Commission and Natural England. Subject to the installation of protective fencing these buffers can be maintained throughout the construction phase.
- 4.1.10. Mitigation for the loss of arboricultural features is provided as part of a post-development landscaping scheme. This scheme includes the planting of woodland areas, specimen trees, shrubs and hedges all of which represent effective replacements for features which cannot be retained.
- 4.1.11. An AMS and TPP have been provided. These lay out the protection measures which should be applied to ensure the sustainable retention of trees. It is envisaged that these documents will be undated to address any currently unforeseen tree protection matter which may arise during subsequent stages of design.

Appendix A

GLOSSARY OF TERMS AND ACRONYMS

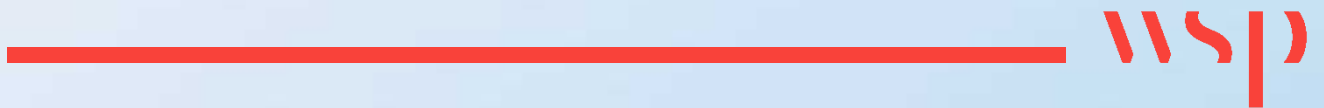

GLOSSARY OF TERMS

Table A-1 - Glossary of Terms

Term	Definition
Ancient Tree	A tree that has passed beyond maturity and is old, or aged, in comparison with trees of the same species. Characterised by biological, cultural or aesthetic features of interest.
Ancient Woodland	Any wooded area that has been continuously wooded since 1600 AD
Arboriculturalist	A person who has, through relevant education, training or experience, gained expertise in the field of trees in relation to construction.
Arboricultural Method Statement	A methodology for the implementation of any aspect of development which is within the root protection area, or has the capacity to adversely affect, any retained tree.
British Standard BS 5837:2012	Provides guidance and recommendations for the integration of trees and development. To be interpreted by appropriately qualified and experienced persons.
Conservation Area	An area of special architectural or historic interest identified by the Local Planning Authority.
Construction Exclusion Zone	An area within which all site clearance and construction activities, access and storage of materials are prohibited.
Crown	The upper part of a tree, measured from the lowest branch, including all branches and foliage.
Root Protection Area	Layout design tool indicating the minimum area around a tree deemed to contain sufficient roots and rooting volume to maintain the tree's vitality.
Tree Preservation Order	An order made by the Local Planning Authority to protect specific trees, groups of trees or woodlands in the interests of amenity.
Veteran Tree	A tree that has the biological or aesthetic characteristics of an ancient tree but is not ancient in years compared with others of the same species.

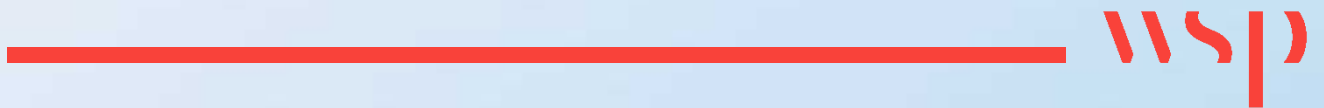

Table A-2 – List of acronyms used within this report

Acronyms	
AIA	Arboricultural Impact Assessment
AMS	Arboricultural Method Statement
BS 5837	British Standard BS 5837:2012 ' <i>Trees in relation to design, demolition and construction – Recommendations</i> '
CEZ	Construction Exclusion Zone
RPA	Root Protection Area
TPO	Tree Preservation Order
TPP	Tree Protection Plan

Appendix B

RELEVANT LEGISLATION, POLICY AND GUIDANCE



This report has been compiled with reference to relevant legislation, policy and guidance. An overview and context are provided in **Table B-1**.

Table B-1 – Summary of relevant legislation, policy and guidance

Legislation

Town and Country Planning Act 1990

Section 197 places a duty on the local planning authority to ensure that, where appropriate, planning conditions are imposed which require the preservation or planting of trees.

Section 198 provides local planning authorities with the powers to impose Tree Preservation Orders where it is expedient in the interests of amenity.

The role of a TPO is to protect specific trees, groups of trees and woodlands for the purpose of amenity. In the Secretary of State's view 'Orders should be used to protect trees and woodlands if their removal would have a significant negative impact on the local environment and its enjoyment by the public.

Town and Country Planning (Tree Preservation) (England) Regulations 2012

These Regulations govern the administration of Tree Preservation Orders. They make it a statutory offence to undertake specified activities without the formal consent of the local planning authority. Prohibited activities include:

- cutting down;
- topping;
- lopping;
- uprooting;
- wilfully damaging; and,
- wilfully destroying.

Exemptions for the need to obtain formal consent include, but are not limited to:

- dead trees;
- the removal of dead branches;
- works necessary to remove a risk of serious harm; and,
- works necessary to implement a planning permission (excluding outline planning permission) or where permission is granted under the *Town and Country Planning (General permitted Development Order 1995)(as amended)*.

The Natural Environment and Rural Communities (NERC) Act 2006

Section 40 of the *Natural Environment and Rural Communities Act 2006* places a duty on local authorities and government departments to have regard for the conservation of biodiversity when exercising their normal functions.

Biodiversity comprises all living things including animals, plants, fungi and micro-organisms and includes the communities and habitats that they form. Trees form integral elements of the natural environment either due to rarity (e.g. Common Juniper (*Juniperus communis*)), as part of an important habitat (e.g. ancient woodland) or because they directly support another species (e.g. a bat roost or nesting bird). Even widespread, common or non-native tree species are important due to their positive contribution towards a sustainable natural environment.

The NERC Act requires that development activities must be undertaken with due regard for trees and their biodiversity value. Trees should be retained wherever practicable and opportunities taken to maintain and enhance their environmental contribution.

Policy

National Planning Policy Framework. (2019)

The National Planning Policy Framework includes relevant guidance in *Chapter 15: Conserving and Enhancing the Natural Environment*. Guidance provided includes:

Paragraph 170(b) recognises the economic and other benefits that trees, and woodlands provide and the fact that they should be considered as part of a planning decision;

Paragraph 175(c) identifies the principle that ‘development resulting in the loss or deterioration of irreplaceable habitats (such as ancient woodland and ancient or veteran trees) should be refused, unless there are wholly exceptional reasons and a suitable compensation strategy exists’.

Arun Local Plan 2011-2031 (adopted July 2018)

Policy ENV DM4 – Protection of trees

This policy requires, that for development to be permitted, it should demonstrate that trees protected by a Tree Preservation Order(s), (TPO) identified as Ancient Woodland, in a Conservation Area or contributing to local amenity, will not be damaged or destroyed now and as they reach maturity, unless development:

- Would result in the removal of one or more trees in the interests of good arboricultural practice;
- Would enhance the survival and growth prospects of other protected trees; or,
- The benefits of the proposed development in a particular location outweigh the loss of trees or woodland, especially ancient woodland.

Guidance

British Standards Institute. 5837:2012 Trees in relation to design, demolition and construction – Recommendations (2012)

British Standard BS 5837:2012 provides recommendations and guidance on the relationship between trees and design, demolition and construction processes. It sets out principles and procedures to be applied to achieve a harmonious and sustainable relationship between trees and structures and is applicable whether or not planning consent is required.

Arun Design Guide Supplementary Planning Document Final Draft 2020

The purpose of this document is to provide further guidance on the design policies contained within Arun’s Local Plan.

Section E.02 provides guidance on landscape structure and trees. In this section it is recommended that development:

- Is informed by arboricultural surveys carried out by a qualified professional at the time of site appraisal;
- Wherever possible retains and incorporates all trees and hedgerows of value, ensuring that their root structure or access to water and sunlight is not adversely impacted by development;
- Re-provides for any loss of trees and incorporates further new planting of a range of species and sizes wherever possible in order to mitigate the impacts of climate change and the urban heat island effect, improve environmental quality and facilitate groundwater absorption, having regard to the provision of below-ground services and the most appropriate species in response;
- Provides for the ongoing maintenance of landscape structures and trees; and,
- Avoids incursion of all Root Protection Areas (RPA) for significant trees of high quality or with TPOs, particularly for larger scale development. Buffer zones should be implemented around RPAs to provide additional protection for such trees.

Ministry of Housing, Communities & Local Government, Tree Preservation Orders and trees in conservation areas (2014)

Provides explanatory guidance on the administration of trees protected by a Tree Preservation Order (TPO) or conservation area.

A key element includes guidance on the use of Orders in instances where the removal of trees where removal would have a 'significant negative impact on the local environment and its enjoyment by the public.' Further guidance is provided on the definition of amenity and includes:

- Visibility - Trees should be visible, in whole or in part, from a public place such as a road, footpath or publicly accessible land.
- Value - Public visibility is in itself not sufficient to warrant inclusion within a TPO. Arboricultural features should also exhibit merit in terms of one or more of the following criteria:
 - Size and form;
 - Future potential;
 - Rarity, cultural or historical value;
 - Contribution to, and relationship with, the landscape; and
 - Contribution to the character or appearance of a conservation area.
- Other Factors - Other factors such as nature conservation may be considered when making a TPO but on their own would not warrant making an Order.

Forestry Commission and Natural England, Ancient woodland, ancient trees and veteran trees: protecting them from development (2018)

The Forestry Commission and Natural England have published guidance giving information for the protection of ancient woodland, ancient trees and veteran trees from development. In summary this guidance advises on the use of semi-natural buffer zones as a means of protection with minimum distances identified as:

- Fifteen metres between any development and ancient woodland.
- Fifteen times the diameter of its stem or 5m from the edge of its canopy, if that's greater, around any ancient or veteran tree.

Further guidance is provided on the compensation measures which may be applied should adverse impacts arise.

Appendix C

ARBORICULTURAL METHOD STATEMENT

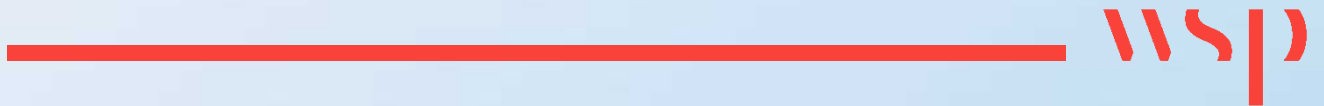

INTRODUCTION

This AMS describes the arboricultural protection measures identified as necessary for the protection of retained trees as part of the Scheme. It presents in principle the arboricultural protection measures which will be applied during construction. It is envisaged that these protection measures will be reviewed by the Design Team prior to the issuing of any tender documentation and that they will be revised to accommodate any design amendment or known construction methodologies.

The following matters have been identified as those which may require inclusion within a revised AMS:

- The phasing of site clearance and construction activities and tree protection measures;
- Arboricultural monitoring and site supervision;
- The location and specification for protective barriers. (Tree protection barriers should be erected prior to any site clearance or construction activities and should remain insitu throughout the construction process. The area to the rear of the protective barriers must be designated as a construction exclusion zone and is an area where all site clearance and construction activities are prohibited);
- The design and construction of boundary fencing;
- The design and construction of surface water drains, ditches and ancillary structures;
- The design and construction of underground services and ducts;
- The design and construction of any structure within the RPA of any retained tree. These should include footpaths, stiles, gates and boundary fencing; and,
- The tree protection measures and working methodology to be applied to soft landscaping activities within the RPA of retained trees.

This AMS must be read in conjunction with the TPP included within **Appendix G** of this report, the Construction Environmental Management Plan and all relevant design drawings, specifications and method statements. This AMS should be viewed as a 'live' document and should be subject to regular review prior to and during construction.

ARBORICULTURAL MONITORING

GENERAL REQUIREMENTS

Effective tree protection can only be achieved by adherence to a logical sequence of works combined with effective arboricultural monitoring. The purpose of arboricultural monitoring is to ensure that all tree protection measures are fit for purpose, are implemented in accordance with any approved details and as a means of enabling any previously unforeseen arboricultural issues to be promptly identified and suitably addressed.

The Principal Contractor will be responsible for ensuring that all site personnel are made aware of the requirements of this AMS and that any future amendments are known and understood. Copies of the approved AMS will be available onsite the requirements of which will be incorporated into all relevant site management documents and site induction procedures.

PRE-COMMENCEMENT

A pre-commencement meeting will be held between the Principal Contractor, local authority tree officer and the project arboriculturist. The purpose of this meeting will be to ensure that all aspects of the tree protection measures are clear and understood and that any future sequencing and supervisory arrangements are agreed. The details of this meeting will be recorded and will be circulated to all parties in writing.

The Principal Contractor shall nominate a person to be responsible for all arboricultural matters onsite. This person must:

- Be present on site whenever work is being undertaken,
- Be aware of their arboricultural responsibilities,
- Have the authority to stop any work that is causing, or has the potential to cause harm to any retained tree,
- Be responsible for ensuring that all site operatives are aware of their responsibilities toward retained trees and the consequences of any failure to observe those responsibilities,
- Make immediate contact with the local authority and/or the project arboriculturist in the event of any tree related problems occurring, whether actual or potential.

DURING / POST-CONSTRUCTION

Once works commence the project arboriculturist will undertake a programme of monitoring. This may include phone and email contact with the site manager, regular site visits and direct monitoring of sensitive works.

The frequency of any monitoring will be determined by the intensity and proximity of works to trees and will be flexible enough to accommodate changes in the scheduling of tasks as they occur on the site.

The project arboriculturist will maintain a record of all aspects of the arboricultural monitoring which has been undertaken. This will provide a record of compliance with any agreed tree protection measures and will assist in the efficient discharge of any relevant planning conditions or demonstration of compliance with any statutory requirements.

TREE PROTECTION FENCING

Purpose

To protect retained trees including their stems, crowns, rooting areas and the soil within which they grow.

General Requirements

Tree protection fencing should be specified by an arboriculturist.

Tree protection fencing will be used to prevent access to the root protection areas (RPAs) of retained trees. In all instances the following specification will be strictly adhered to:

- The area to the rear of the tree protection fencing shall be considered to form a Construction Exclusion Zone. No construction activities, storage of materials or pedestrian or vehicular access shall take place within this area.
- All weather notices will be attached to the tree protection fencing at suitable intervals and shall include suitably sized informative text containing the following statement:

**“TREE PROTECTION FENCING
CONSTRUCTION EXCLUSION ZONE – NO ACCESS”**

- Regular daily checks will be carried out by an appointed person to ensure that all tree protection fencing is still in place and functioning; any damage will be rectified without delay.

Timing

- Tree protective fencing shall be erected prior to any works onsite including site clearance, ground work or the importation of plant and materials.
- Once erected tree protection fencing shall remain in-situ until all construction activities are complete.

Specification for Fencing

- Tree protection fencing shall be fit for the purpose of excluding construction activity and appropriate for the degree and proximity of work taking place. An example of the type of tree protection fencing which may be required is included in Figure C-1.

Figure C-1 - Example of appropriate tree protection fencing

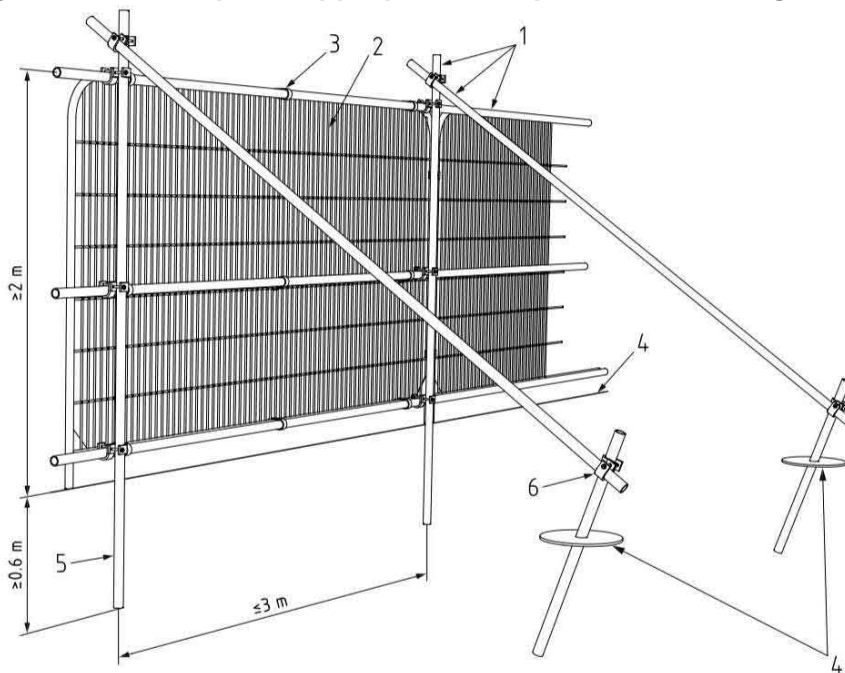

Key:

1. Standard scaffold poles
2. Heavy guage 2m tall galvanised tube and welded mesh infill panels
3. Panels secured to uprights and cross-members with wire ties
4. Ground level
5. Uprights driven into the ground until secure (minimum depth 0.6m)
6. Standard scaffold clamps

Appendix D

ARBORICULTURAL SURVEY METHODOLOGY

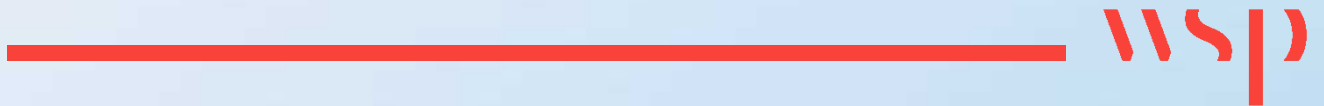

SURVEY METHODOLOGY

METHOD OF BASELINE DATA COLLECTION

Baseline data collection has been undertaken with reference to BS 5837 and has been undertaken using the following data sources:

- An arboricultural desk study, and;
- A walkover survey of all arboricultural features within the study area.

DESK STUDY

A desk-study has been undertaken as a means of identifying any statutory and non-statutory constraints which may apply to arboricultural features within the Study Area. The desk-based review has considered the following sources:

TPOs and Conservation Areas

Arun District Council is responsible for implementing any legal controls imposed through TPOs and conservation areas within the study area. The statutory status of arboricultural features within the study area was checked using the Council's online mapping system¹¹.

Ancient and Veteran Trees

The potential presence of ancient and veteran trees within the study area was checked using the Woodland Trust's Ancient Tree Inventory¹².

Ancient Woodland

The potential presence of ancient woodlands within the study area was checked using Natural England's Multi Agency Geographical Information for the Countryside (MAGIC) map¹³.

¹¹ Arun District Council, 2020. *Arun Maps* [online] Available at: <https://www1.arun.gov.uk/webapps/wml/> [Accessed 17 August 2020].

¹² Ancient Tree Inventory, 2020. *Ancient Tree Inventory* [online] Available at: < <https://ati.woodlandtrust.org.uk/> > [Accessed 17 August 2020].

¹³ Magic (DEFRA), 2020. *Multi Agency Geographical Information for the Countryside* [online] Available at: < <https://magic.defra.gov.uk/MagicMap.aspx> > [17 August 2020].

WALKOVER SURVEY

A walkover survey was undertaken on 08 May 2019. The walkover survey was conducted by Theresa Reichlin (Arboricultural Consultant) with aerial imagery used as base mapping.

The walkover survey was undertaken in accordance with the following criteria:

- Arboricultural features have been recorded as tree groups or wooded areas where this has been deemed appropriate. Tree groups have been recorded on the basis that they form distinct arboricultural features either aerodynamically, visually or because they contain trees of similar cultural and biodiversity value. Wooded areas are recorded where larger expanses of trees exist and included features which may otherwise be referred to as copses, spinneys or shelterbelts.
- Hedges have been recorded where they form substantial internal or boundary features or where they contribute meaningfully to the landscape character of the local area.
- The trees have been inspected using the Visual Tree Assessment methodology as developed by Mattheck and Breoler¹⁴.
- The tree survey was carried out from ground level only.
- No tissue samples were taken nor was any internal investigation of the subject trees undertaken.
- Tree heights and crown spreads have been estimated to the nearest 1m.
- Notes have been recorded where they relate to the quality of the arboricultural feature. Management recommendations have been provided where work is necessary for the abatement of a hazard which presents a high level of risk to persons or property. Such management recommendations have been communicated to the tree owner/manager separately from this report.

Stem diameters have been measured in accordance with Annex C of BS 5837. Diameters of single stem trees on level ground have been measured at 1.5m above ground level. The diameters of other commonly encountered stems have been measured as per the guidance. The combined stem diameters for multi-stemmed trees have been calculated in accordance with BS 5837 paragraph 4.6.1.

By default, Root Protection Areas (RPAs) are calculated as an area equivalent to a circle with a radius 12 times the stem diameter and are capped at a distance of 15 metres. However, for ancient and veteran trees RPAs are calculated with a radius of 15 times the stem diameter or five metres beyond the edge of the tree's canopy, whichever is greater¹⁵. In these instances, the overall size of the RPA remains uncapped.

QUALITY ASSESSMENT

The quality of arboricultural features has been determined in accordance with BS 5837 Table 1 a copy of which is provided in Figure D-1. The purpose of the quality assessment is to enable informed decisions to be made regarding the removal and retention of arboricultural features in the context of development. For an arboricultural feature to be included within a particular quality category it should accord with the description provided.

¹⁴ Mattheck, C., Breloer, H., 2006. *The body language of trees*. Norwich: The Stationary Office

¹⁵ Lonsdale, D., 2013. *Ancient and other veteran trees: further guidance on management*. London: The Tree Council.

The quality of each arboricultural feature is defined based on its sub-category. Sub-categories carry equal weight, do not influence retention priority and are simply included to indicate the primary value associated with each surveyed item. Sub-categories 1, 2 and 3 are intended to reflect arboricultural, landscape and cultural values, respectively.

The quality and sub-category assigned to each arboricultural feature are identified within the Arboricultural Survey Schedule included in Appendix E of this report.

Figure D-1 - BS 5837 Table 1 - Cascade Chart for Tree Quality Assessment

Table 1 Cascade chart for tree quality assessment

Category and definition	Criteria (including subcategories where appropriate)	Identification on plan
Trees unsuitable for retention (see Note)		
Category U Those in such a condition that they cannot realistically be retained as living trees in the context of the current land use for longer than 10 years	<ul style="list-style-type: none"> Trees that have a serious, irremediable, structural defect, such that their early loss is expected due to collapse, including those that will become unviable after removal of other category U trees (e.g. where, for whatever reason, the loss of companion shelter cannot be mitigated by pruning) Trees that are dead or are showing signs of significant, immediate, and irreversible overall decline Trees infected with pathogens of significance to the health and/or safety of other trees nearby, or very low quality trees suppressing adjacent trees of better quality <p><i>NOTE Category U trees can have existing or potential conservation value which it might be desirable to preserve; see 4.5.7.</i></p>	See Table 2
	1 Mainly arboricultural qualities	2 Mainly landscape qualities
		3 Mainly cultural values, including conservation
Trees to be considered for retention		
Category A Trees of high quality with an estimated remaining life expectancy of at least 40 years	Trees that are particularly good examples of their species, especially if rare or unusual; or those that are essential components of groups or formal or semi-formal arboricultural features (e.g. the dominant and/or principal trees within an avenue)	See Table 2
Category B Trees of moderate quality with an estimated remaining life expectancy of at least 20 years	Trees that might be included in category A, but are downgraded because of impaired condition (e.g. presence of significant though remediable defects, including unsympathetic past management and storm damage), such that they are unlikely to be suitable for retention for beyond 40 years; or trees lacking the special quality necessary to merit the category A designation	See Table 2
Category C Trees of low quality with an estimated remaining life expectancy of at least 10 years, or young trees with a stem diameter below 150 mm	Unremarkable trees of very limited merit or such impaired condition that they do not qualify in higher categories	See Table 2

NOTES AND LIMITATIONS

Arboricultural survey data is of a preliminary nature and has been collected based on a walkover survey. Only defects visible from the ground have been noted and each individual feature may not have been inspected closely due to access difficulties, the presence of dense ivy, other vegetation or safety constraints. Safety related features have recorded on the basis that the arboricultural features will be subject to a normal programme of tree hazard assessment and only those features which materially affect the quality of the feature or pose a real and immediate safety concern have been recorded.

Arboricultural survey data is typically valid for a period of two years unless otherwise stated. Significant environmental events (such as extreme weather conditions) or changes to the Site may render it invalid within a shorter timescale.



Records held on the Ancient Tree Inventory¹⁶ are collected on a voluntary basis, therefore the absence of records does not demonstrate the absence of ancient or veteran trees but may simply indicate a gap in recording coverage.

Whilst arboricultural surveys are not seasonally limited it is the case that certain pests and diseases may be more or less evident at different times of the year. This is especially true of certain wood decaying fungi such as the Giant Polypore (*Meripilus giganteus*) where fruiting bodies are short-lived, and the early stages of root decay may not result in other identifiable symptoms. Walkover survey data is therefore based upon observations made at the time of the site visit and may be subject to change should further or more detailed inspections be undertaken.

The survey has only been undertaken from land within the client's ownership, from public land or from areas where formal access has been arranged.

The position of arboricultural features not recorded on a topographical survey has been estimated using aerial photography. The position and extent of these features should be regarded as approximate only.

¹⁶ Ancient Tree Inventory, 2018. *Ancient Tree Inventory* [online] Available at: < <https://ati.woodlandtrust.org.uk>>

Appendix E

ARBORICULTURAL SURVEY SCHEDULE

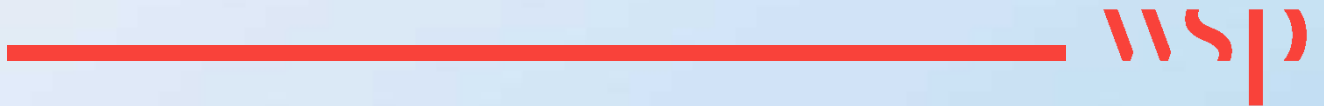



Key:	Description			
REFERENCE NUMBER:	Individual reference number			
TYPE:	T - Tree	G – Tree Group	W – Wooded Area	H - Hedge
SPECIES:	Species listed by common name			
HEIGHT:	Overall height (m) – maximum and minimum heights may be recorded for tree groups, wooded areas and hedges where these vary considerably or are deemed to be noteworthy			
DIAMETER:	Stem diameter (mm) calculated in accordance with BS 5837 paragraph 4.6.1. An average stem diameter is provided for tree groups, wooded areas and hedges			
CROWN SPREAD	Spread of crown based upon the maximum lateral dimension (m)			
LCH:	Lowest crown height (m)		* Where an arboricultural feature abuts the edge of the study area then only the portion of the crown within/overhanging the study area will be surveyed and recorded	
FSB:	Height of lowest significant branch (m)			
AGE CLASS:	Young - < 1/3rd estimated life expectancy	Semi-mature – 1/3rd to 2/3rd estimated life expectancy	Mature - > 2/3rd estimated life expectancy	Veteran – a tree which exists significantly beyond its normal life expectancy
PHYSIOLOGICAL CONDITION:	Good	Fair	Poor	Dead
STRUCTURAL CONDITION:	Good	Fair	Poor	
ESTIMATED REMAINING CONTRIBUTION:	>10 years	10+ years	20+ years	40+ years
CATEGORY:	BS 5837 Category - A, B, C, U		BS 5837 Sub-category - 1, 2, 3	
RPA RADIUS	The radius of the circular Root Protection Area associated with the tree as measured from the centre of the stem (m). For arboricultural features where more than one stem diameter is recorded the RPA radius is calculated using the largest dimension.			



TREE NO	TYPE	SPECIES	HEIGHT (m)	STEM DIAMETER (mm)	MAXIMUM CROWN SPREAD	LCH	LBH	AGE CLASS	PHYSIOLOGICAL CONDITION	STRUCTURAL CONDITION	ESTIMATED REMAINING CONTRIBUTION	CATEGORY	SUB-CATEGORY	NOTES	RPA RADIUS (m)	STATUTORY STATUS	ENVIRONMENTAL STATUS
1	T	Norway Maple	10.0	630	4.0	2.0	2.0	Mature	Good	Good	10+	C	2	-	7.6	-	-
2	T	Oak	20.0	1300	10.0	1.0	0.0	Mature	Good	Fair	40+	A	3	-	19.5	TPO/BN/1/20 - T29	Veteran
3	T	Oak	15.0	740	8.0	4.0	3.0	Mature	Good	Good	40+	A	2	-	8.9	TPO/BN/1/20 - T15	-
5	T	Evergreen Oak	14.0	400	4.5	1.0	1.0	Mature	Good	Good	20+	B	2	No access; all data estimated	4.8	-	-
6	T	Norway Maple	8.0	340	3.0	2.0	2.0	Mature	Good	Good	10+	C	2	-	4.1	-	-
7	T	Poplar	18.0	750	6.5	5.0	1.0	Mature	Fair	Fair	20+	B	2	-	9.0	-	-
10	T	Oak	18.0	850	8.0	3.0	3.0	Mature	Good	Good	40+	A	2	No safe access; all data estimated; deadwood present	10.2	-	-



TREE NO	TYPE	SPECIES	HEIGHT (m)	STEM DIAMETER (mm)	MAXIMUM CROWN SPREAD	LCH	LBH	AGE CLASS	PHYSIOLOGICAL CONDITION	STRUCTURAL CONDITION	ESTIMATED REMAINING CONTRIBUTION	CATEGORY	SUB-CATEGORY	NOTES	RPA RADIUS (m)	STATUTORY STATUS	ENVIRONMENTAL STATUS
11	T	Oak	10.0	600	5.0	1.0	2.0	Mature	Good	Good	20+	B	2	Prolific ivy	7.2	TPO/BN/1/20 - T31	-
12	T	Norway Maple	10.0	470	4.0	2.0	2.0	Mature	Good	Good	10+	C	2	-	5.6	-	-
14	T	Cypress	12.0	500	5.0	1.0	1.0	Mature	Fair	Good	10+	C	2	-	6.0	-	-
15	T	Norway Maple	10.0	470	4.0	2.0	2.0	Mature	Good	Good	10+	C	2	-	5.6	-	-
16	T	Norway Maple	8.0	280	3.0	2.0	2.0	Mature	Good	Good	10+	C	2	-	3.4	-	-
17	T	Lawson Cypress	12.0	800	3.0	0.0	3.0	Mature	Fair	Poor	10+	C	2	-	9.6	-	-
18	T	Oak	8.0	310	3.5	3.0	1.0	Semi-Mature	Good	Good	10+	C	2	-	3.7	-	-
19	T	Norway Maple	8.0	320	3.0	2.0	2.0	Mature	Good	Good	10+	C	2	-	3.8	-	-
20	T	Oak	20.0	1300	10.0	1.0	0.0	Mature	Good	Fair	40+	A	3	-	19.5	TPO/BN/1/20 - T27	Veteran



TREE NO	TYPE	SPECIES	HEIGHT (m)	STEM DIAMETER (mm)	MAXIMUM CROWN SPREAD	LCH	LBH	AGE CLASS	PHYSIOLOGICAL CONDITION	STRUCTURAL CONDITION	ESTIMATED REMAINING CONTRIBUTION	CATEGORY	SUB-CATEGORY	NOTES	RPA RADIUS (m)	STATUTORY STATUS	ENVIRONMENTAL STATUS
21	T	Apple	6.0	410	4.0	1.0	1.0	Mature	Poor	Poor	10+	C	1	-	4.9	-	-
23	T	Oak	19.0	1200	12.0	0.0	4.0	Mature	Good	Fair	40+	A	3	-	18.0	TPO/BN/1/20 - T18	Veteran
24	T	Norway Maple	8.0	450	3.0	2.0	2.0	Mature	Good	Good	10+	C	2	-	5.4	-	-
25	T	Oak	20.0	1300	12.0	0.0	4.0	Mature	Good	Fair	40+	A	1	-	15.0	TPO/BN/1/20 - T16	-
26	T	Norway Maple	10.0	470	4.0	2.0	2.0	Mature	Good	Good	10+	C	2	-	5.6	-	-
27	T	Apple	5.0	750	4.0	1.0	1.0	Mature	Dying/Dead	Poor	10+	C	2	-	9.0	-	-
31	T	Lawson Cypress	12.0	800	3.0	0.0	3.0	Mature	Fair	Poor	10+	C	2	-	9.6	-	-
32	T	Hawthorn	6.0	270	2.5	1.5	0.0	Mature	Good	Poor	10+	C	2	-	3.2	-	-
33	T	Norway Maple	8.0	260	3.0	2.0	2.0	Mature	Good	Good	10+	C	2	-	3.1	-	-



TREE NO	TYPE	SPECIES	HEIGHT (m)	STEM DIAMETER (mm)	MAXIMUM CROWN SPREAD	LCH	LBH	AGE CLASS	PHYSIOLOGICAL CONDITION	STRUCTURAL CONDITION	ESTIMATED REMAINING CONTRIBUTION	CATEGORY	SUB-CATEGORY	NOTES	RPA RADIUS (m)	STATUTORY STATUS	ENVIRONMENTAL STATUS
34	T	Norway Maple	8.0	320	3.0	2.0	2.0	Mature	Good	Good	10+	C	2	-	3.8	-	-
38	T	Ash	8.0	110	1.5	3.0	3.0	Young	Good	Good	10+	C	2	-	1.3	-	-
39	T	Oak	16.0	860	8.0	0.0	1.5	Mature	Good	Good	20+	B	2	-	10.3	TPO/BN/1/20 - T8	-
40	T	Oak	10.0	650	5.0	1.0	2.5	Mature	Good	Good	20+	B	2	-	7.8	-	-
41	T	Oak	9.0	320	3.5	2.0	2.5	Mature	Good	Good	10+	C	2	-	3.8	-	-
42	T	Oak	18.0	1900	10.0	1.0	1.0	Mature	Good	Fair	40+	A	3	-	28.5	TPO/BN/1/20 - T17	Veteran
44	T	Oak	7.0	360	4.0	0.0	1.5	Semi-Mature	Good	Good	10+	C	2	-	4.3	-	-
45	T	Evergreen Oak	18.0	1000	9.0	12.0	1.0	Mature	Good	Good	40+	A	2	No access; all data estimated;	12.0	-	-
46	T	Hawthorn	5.0	350	2.0	0.0	0.0	Mature	Good	Poor	10+	C	2	-	4.2	-	-
48	T	Apple	6.0	410	4.0	1.0	1.0	Mature	Poor	Poor	10+	C	1	-	4.9	-	-



TREE NO	TYPE	SPECIES	HEIGHT (m)	STEM DIAMETER (mm)	MAXIMUM CROWN SPREAD	LCH	LBH	AGE CLASS	PHYSIOLOGICAL CONDITION	STRUCTURAL CONDITION	ESTIMATED REMAINING CONTRIBUTION	CATEGORY	SUB-CATEGORY	NOTES	RPA RADIUS (m)	STATUTORY STATUS	ENVIRONMENTAL STATUS
50	T	Evergreen Oak	18.0	800	7.0	5.0	3.0	Mature	Fair	Fair	20+	B	2	Stem damage 10 m above ground.	9.6	-	-
51	T	Apple	6.0	410	4.0	1.0	1.0	Mature	Poor	Poor	10+	C	1	-	4.9	-	-
52	T	Apple	7.0	510	4.0	2.0	1.0	Mature	Poor	Poor	10+	C	3	-	6.1	-	-
54	T	Norway Maple	10.0	600	4.0	2.0	2.0	Mature	Good	Good	10+	C	2	-	7.2	-	-
55	T	Oak	17.0	800	5.0	1.0	3.0	Mature	Good	Fair	20+	B	2	-	9.6	-	-
57	T	Norway Maple	8.0	260	3.0	2.0	2.0	Mature	Good	Good	10+	C	2	-	3.1	-	-
58	T	Norway Maple	8.0	340	3.0	2.0	2.0	Mature	Good	Good	10+	C	2	-	4.1	-	-
59	T	Oak	7.0	200	2.0	3.0	2.5	Semi-Mature	Good	Good	10+	C	2	-	2.4	-	-
60	T	Scots Pine	8.0	290	2.0	5.0	4.0	Mature	Fair	Poor	10+	C	2	-	3.5	-	-



TREE NO	TYPE	SPECIES	HEIGHT (m)	STEM DIAMETER (mm)	MAXIMUM CROWN SPREAD	LCH	LBH	AGE CLASS	PHYSIOLOGICAL CONDITION	STRUCTURAL CONDITION	ESTIMATED REMAINING CONTRIBUTION	CATEGORY	SUB-CATEGORY	NOTES	RPA RADIUS (m)	STATUTORY STATUS	ENVIRONMENTAL STATUS
63	T	Lime	9.0	300	3.5	0.0	0.0	Semi-Mature	Good	Fair	10+	C	2	No safe access; all data estimated;	3.6	-	-
64	T	Hawthorn	6.0	260	3.5	0.0	0.0	Mature	Good	Good	10+	C	1	-	3.1	-	-
65	G	Field Maple	6.0	150	1.0	0.0	0.0	Young	Good	Good	10+	C	2	-	1.8	-	-
66	H	Leyland Cypress	6.0	120	1.0	0.0	0.0	Semi-Mature	Good	Good	10+	C	2	-	1.4	-	-
67	G	Lombardy Poplar; Leyland Cypress	15.0	350	4.5	0.0	0.0	Mature	Good	Fair	10+	C	2	-	4.2	-	-
68	G	Liquidambar	9.0	250	2.5	0.0	0.0	Mature	Good	Fair	10+	C	2	-	3.0	-	-
69	H	Poplar	6.0	120	1.0	0.0	0.0	Young	Good	Good	10+	C	2	Topped	1.4	-	-
71	G	Lombardy Poplar	17.0	850	4.0	4.0	2.0	Mature	Good	Fair	20+	B	2	-	10.2	-	-



TREE NO	TYPE	SPECIES	HEIGHT (m)	STEM DIAMETER (mm)	MAXIMUM CROWN SPREAD	LCH	LBH	AGE CLASS	PHYSIOLOGICAL CONDITION	STRUCTURAL CONDITION	ESTIMATED REMAINING CONTRIBUTION	CATEGORY	SUB-CATEGORY	NOTES	RPA RADIUS (m)	STATUTORY STATUS	ENVIRONMENTAL STATUS
73	G	Field Maple; Hawthorn; Oak	7.0	250	1.5	0.0	0.0	Semi-Mature	Good	Good	10+	C	2	-	3.0	-	-
74	G	Apple; Ash	7.0	250	1.5	0.0	0.0	Semi-Mature	Good	Good	10+	C	2	-	3.0	-	-
75	H	Leyland Cypress	6.0	120	1.0	0.0	0.0	Semi-Mature	Good	Good	10+	C	2	-	1.4	-	-
76	G	Apple; Poplar	10.0	300	3.5	0.0	0.0	Mature	Good	Good	10+	C	2	-	3.6	-	-
77	G	Apple	4.0	150	1.5	1.0	0.0	Mature	Poor	Poor	10+	C	2	-	1.8	-	-
78	H	Sycamore	2.0	75	0.5	0.0	0.0	Semi-Mature	Good	Good	10+	C	2	-	0.9	-	-
81	G	Gleditsia	11.0	400	4.0	0.0	0.0	Mature	Good	Good	10+	C	2	No access; all data estimated	4.8	-	-
82	G	Field Maple; Beech; Hawthorn	8.0	200	3.0	0.0	0.0	Semi-Mature	Good	Good	10+	C	2	-	2.4	-	-



TREE NO	TYPE	SPECIES	HEIGHT (m)	STEM DIAMETER (mm)	MAXIMUM CROWN SPREAD	LCH	LBH	AGE CLASS	PHYSIOLOGICAL CONDITION	STRUCTURAL CONDITION	ESTIMATED REMAINING CONTRIBUTION	CATEGORY	SUB-CATEGORY	NOTES	RPA RADIUS (m)	STATUTORY STATUS	ENVIRONMENTAL STATUS
83	H	Blackthorn; Hawthorn; Elder	3.0	150	1.5	0.0	0.0	Mature	Good	Good	10+	C	2	-	0.2	-	-
84	H	Blackthorn; Hawthorn; Elder	3.0	150	1.5	0.0	0.0	Mature	Good	Good	10+	C	2	-	1.8	-	-
85	G	Hornbeam	12.0	350	6.0	1.0	0.0	Mature	Good	Good	20+	B	2	-	4.2	TPO/BN/1/20 - G37	-
86	G	Leyland Cypress	14.0	300	2.0	0.0	0.0	Mature	Good	Good	10+	C	2	-	3.6	-	-
88	G	Leyland Cypress	16.0	400	5.0	0.0	0.0	Mature	Good	Fair	10+	C	2	No access; all data estimated	4.8	-	-
91	G	Birch; Norway Maple	4.0	200	3.0	0.0	0.0	Semi- Mature	Good	Good	10+	C	2	-	2.4	-	-



TREE NO	TYPE	SPECIES	HEIGHT (m)	STEM DIAMETER (mm)	MAXIMUM CROWN SPREAD	LCH	LBH	AGE CLASS	PHYSIOLOGICAL CONDITION	STRUCTURAL CONDITION	ESTIMATED REMAINING CONTRIBUTION	CATEGORY	SUB-CATEGORY	NOTES	RPA RADIUS (m)	STATUTORY STATUS	ENVIRONMENTAL STATUS
92	G	Elder; Cherry; Apple; Oak; Hawthorn	8.0	350	3.0	0.0	0.0	Mature	Fair	Fair	10+	C	2	-	4.2	-	-
93	G	Field Maple; Holly; Hawthorn	8.0	230	2.5	0.0	0.0	Semi-Mature	Good	Good	10+	C	2	-	2.8	-	-
95	G	Native Mix	7.0	200	1.5	0.0	0.0	Young	Good	Good	10+	C	2	-	2.4	-	-
96	G	Field Maple, Goat Willow, Willow, Ash, Birch, Hazel	10.0	250	4.0	0.0	0.0	Semi-Mature	Good	Fair	10+	C	2	-	3.0	-	-
97	G	Elder; Cherry; Apple; Oak; Hawthorn	8.0	350	3.0	0.0	0.0	Mature	Fair	Fair	10+	C	2	-	4.2	-	-
97	G	Elder; Cherry; Apple; Oak; Hawthorn	8.0	350	3.0	0.0	0.0	Mature	Fair	Fair	10+	C	2	-	4.2	-	-



TREE NO	TYPE	SPECIES	HEIGHT (m)	STEM DIAMETER (mm)	MAXIMUM CROWN SPREAD	LCH	LBH	AGE CLASS	PHYSIOLOGICAL CONDITION	STRUCTURAL CONDITION	ESTIMATED REMAINING CONTRIBUTION	CATEGORY	SUB-CATEGORY	NOTES	RPA RADIUS (m)	STATUTORY STATUS	ENVIRONMENTAL STATUS
98	G	Apple	8.0	350	3.5	0.0	0.0	Mature	Fair	Fair	10+	C	3	-	4.2	-	-
99	G	Apple; Hawthorn; Sycamore; Elder	7.0	300	5.0	0.0	0.0	Mature	Good	Fair	10+	C	3	-	3.6	-	-
100	G	Ash, Field Maple, Oak	5.0	250	3.0	0.0	0.0	Young	Good	Good	10+	C	2	No access; all data estimated	3.0	-	-
104	G	Leyland Cypress	12.0	300	3.0	1.0	0.0	Semi- Mature	Fair	Poor	10+	C	2	-	3.6	-	-
107	G	Apple; Hawthorn; Sycamore; Elder; Ash	8.0	450	5.0	0.0	0.0	Mature	Good	Fair	10+	C	3	-	5.4	-	-

Appendix F

SUPPORTING DOCUMENTATION

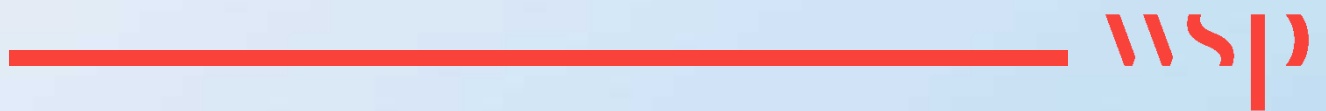

Figure F-1 - TPO/BN/1/20 - Map 1

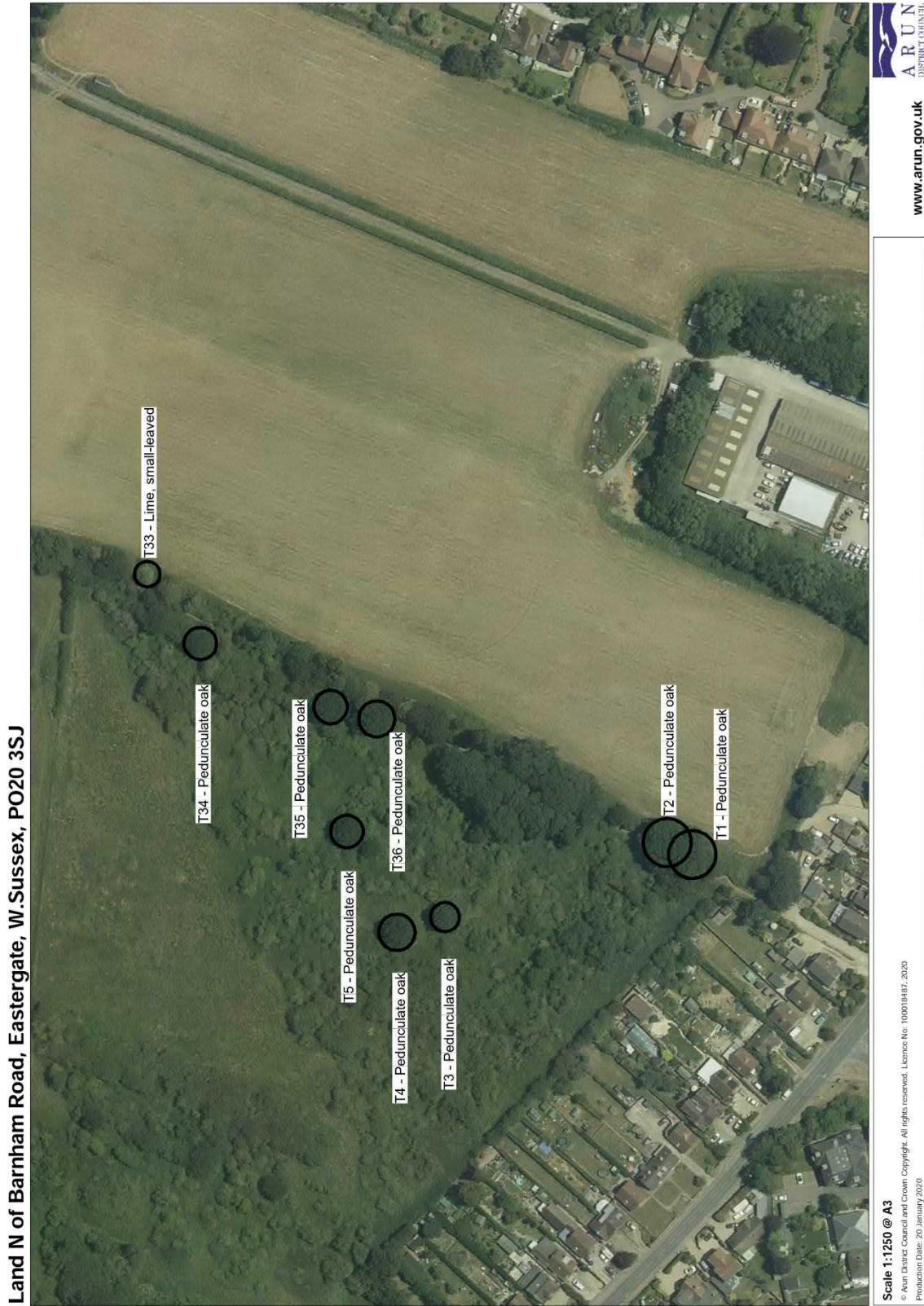
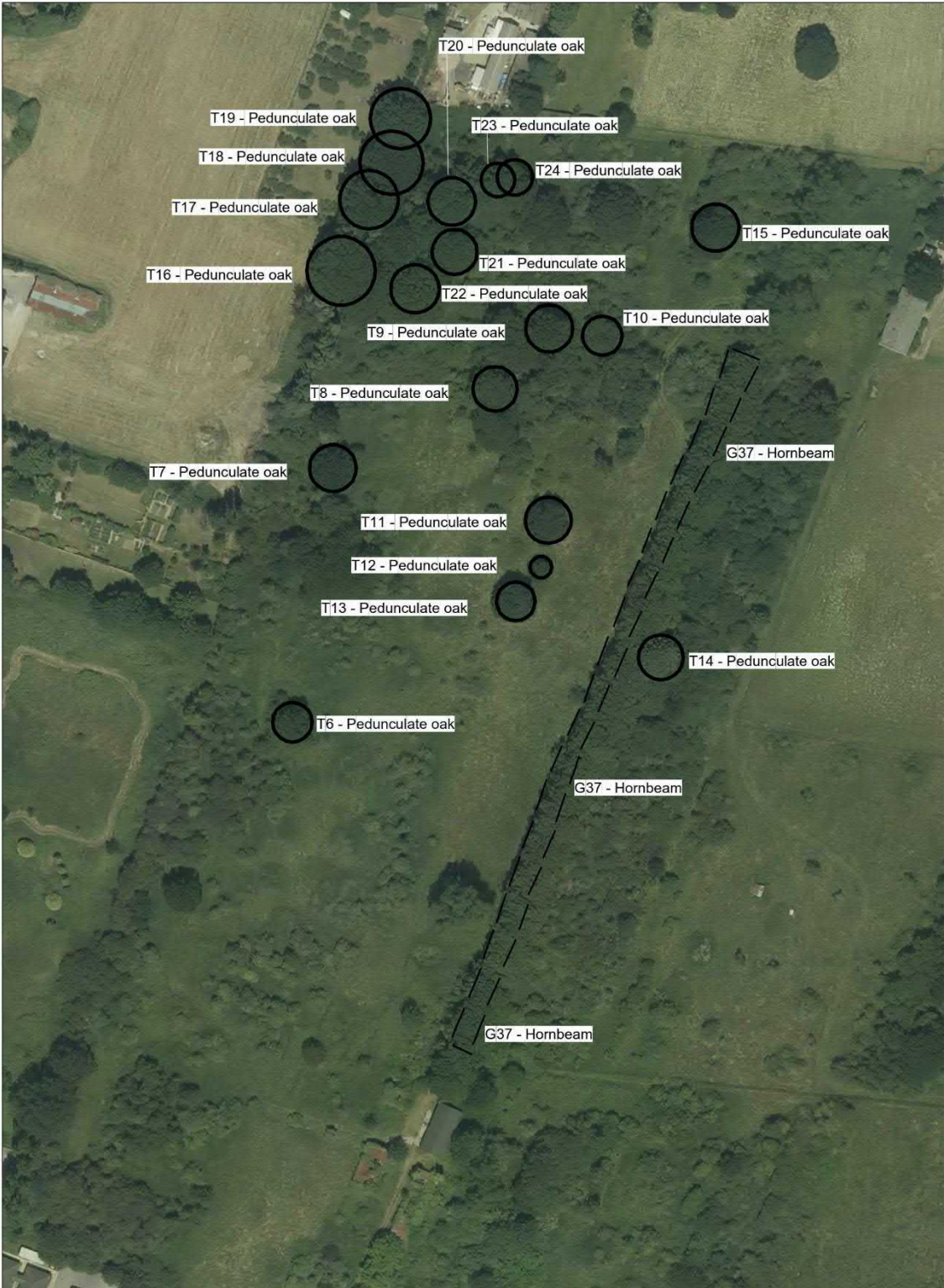

Figure F-2 - TPO/BN/1/20 - Map 2

Land N of Barnham Road, Eastergate, W.Sussex, PO20 3SJ



Scale 1:1250 @ A3
© Arun District Council and Crown Copyright. All rights reserved. Licence No: 100018487, 2020
Production Date: 20 January 2020

Figure F-3 - TPO/BN/1/20 - Map 3

Land N of Barnham Road, Eastergate, W.Sussex, PO20 3SJ



Scale 1:1250 @ A3
© Arun District Council and Crown Copyright. All rights reserved. Licence No: 100018487, 2020
Production Date: 20 January 2020

Appendix G

TREE PROTECTION PLANS

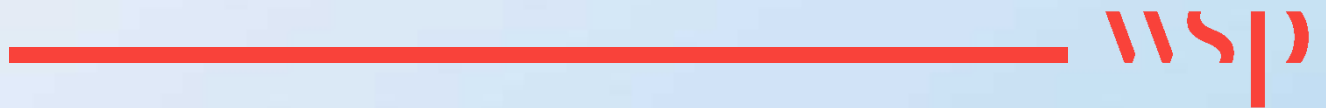

DO NOT SCALE

- NOTES:
1. ALL DIMENSIONS ARE IN METRES UNLESS OTHERWISE STATED.
 2. DO NOT SCALE, IF IN DOUBT CONTACT WSP PROJECT MANAGER.
 3. THE WORKS SHALL BE CARRIED OUT IN ACCORDANCE WITH THE DFT MCHW, DMRB AND THE LOCAL REQUIREMENTS OF WEST SUSSEX COUNTY COUNCIL DESIGN GUIDE & SPECIFICATIONS.

- KEY:
- T TREE
 - G TREE GROUP
 - H HEDGE
 - BS 5837 CATEGORY GRADING / QUALITY
 - + A CATEGORY / HIGH
 - + B CATEGORY / MODERATE
 - + C CATEGORY / LOW
 - ROOT PROTECTION AREA
 - SEMI-NATURAL BUFFER - POTENTIAL VETERAN TREES
 - TREE CANOPY
 - ARBORICULTURAL FEATURE TO BE REMOVED
 - △ TPO TREE (UN-SURVEYED)
 - △ TPO TREE GROUP (UN-SURVEYED)
 - △ TREE GROUP - UN-SURVEYED
 - PLANNING APPLICATION BOUNDARY
 - ARBORICULTURAL STUDY AREA (WALKOVER SURVEY)
 - ARBORICULTURAL STUDY AREA (DESK STUDY)

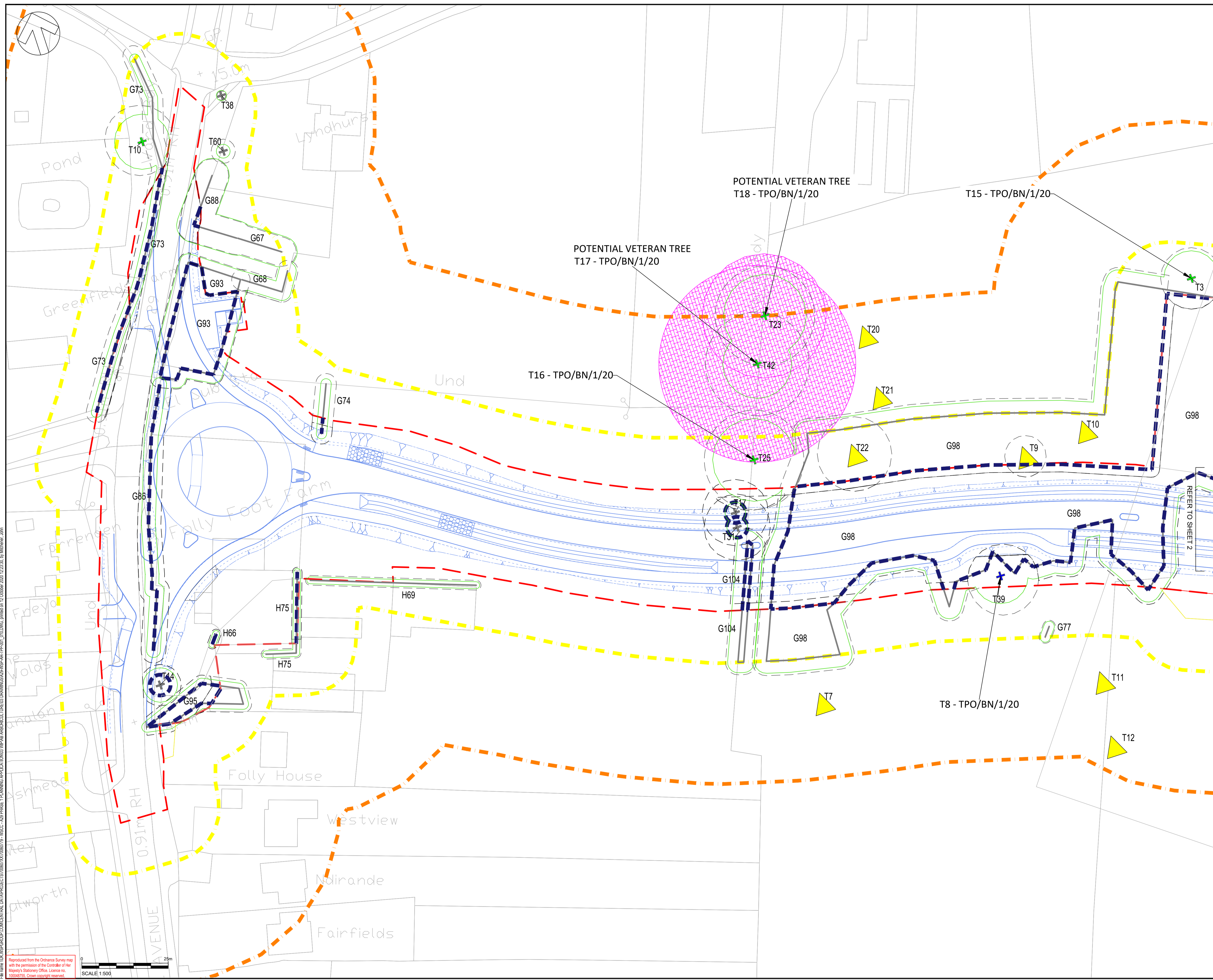

REV	DATE	BY	DESCRIPTION	CHK	APP
B	08/10/2020	JM	UPDATED RLB	CIT	ND
A	21/08/2020	JM	FIRST ISSUE	CIT	ND

DRAWING STATUS: S3 - FOR REVIEW



1 Capital Quarter, Tyndall St, Cardiff, CF10 4BZ, UK
T+ 44 (0) 292 076 9200
wsp.com

CLIENT: WEST SUSSEX COUNTY COUNCIL

ARCHITECT:

SITE PROJECT: A29 REALIGNMENT PHASE 1

TITLE: TREE PROTECTION PLAN (TREE REMOVALS) (SHEET 1 OF 10)

SCALE @ A1:	CHECKED:	APPROVED:
1:500	CIT	ND

PROJECT NO:	DESIGNED:	DRAWN:	DATE:
70060779	JM	JM	October 20

DRAWING No: A29-WSP-AR-TPP-001 REV: B

© WSP UK Ltd

File: \\wsp\group\commercial_data\projects\70060779\70060779_010\DRAWING_PLAN\AR-TPP-001.dwg, printed on 12 October 2020 12:23:30, by Michael, John
 Reproduced from the Ordnance Survey map with the permission of the Controller of Her Majesty's Stationary Office. Licence no. 100048735. Crown copyright reserved.

SCALE: 1:500

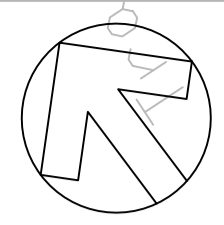

POTENTIAL VETERAN TREE (ATI REF. 97690)
T27 - TPO/BN/1/20

POTENTIAL VETERAN TREE (ATI REF. 97691)
T29 - TPO/BN/1/20

DO NOT SCALE

- NOTES:
- ALL DIMENSIONS ARE IN METRES UNLESS OTHERWISE STATED.
 - DO NOT SCALE, IF IN DOUBT CONTACT WSP PROJECT MANAGER.
 - THE WORKS SHALL BE CARRIED OUT IN ACCORDANCE WITH THE DFT MCHW, DMRB AND THE LOCAL REQUIREMENTS OF WEST SUSSEX COUNTY COUNCIL DESIGN GUIDE & SPECIFICATIONS.

- KEY:
- T TREE
 - G TREE GROUP
 - H HEDGE
- BS 5837 CATEGORY GRADING / QUALITY
- A CATEGORY / HIGH
 - B CATEGORY / MODERATE
 - C CATEGORY / LOW
- ROOT PROTECTION AREA
 - SEMI-NATURAL BUFFER - POTENTIAL VETERAN TREES
 - TREE CANOPY
 - ARBOICULTURAL FEATURE TO BE REMOVED
 - TPO TREE (UN-SURVEYED)
 - TPO TREE GROUP (UN-SURVEYED)
 - TREE GROUP - UN-SURVEYED
 - PLANNING APPLICATION BOUNDARY
 - ARBOICULTURAL STUDY AREA (WALKOVER SURVEY)
 - ARBOICULTURAL STUDY AREA (DESK STUDY)

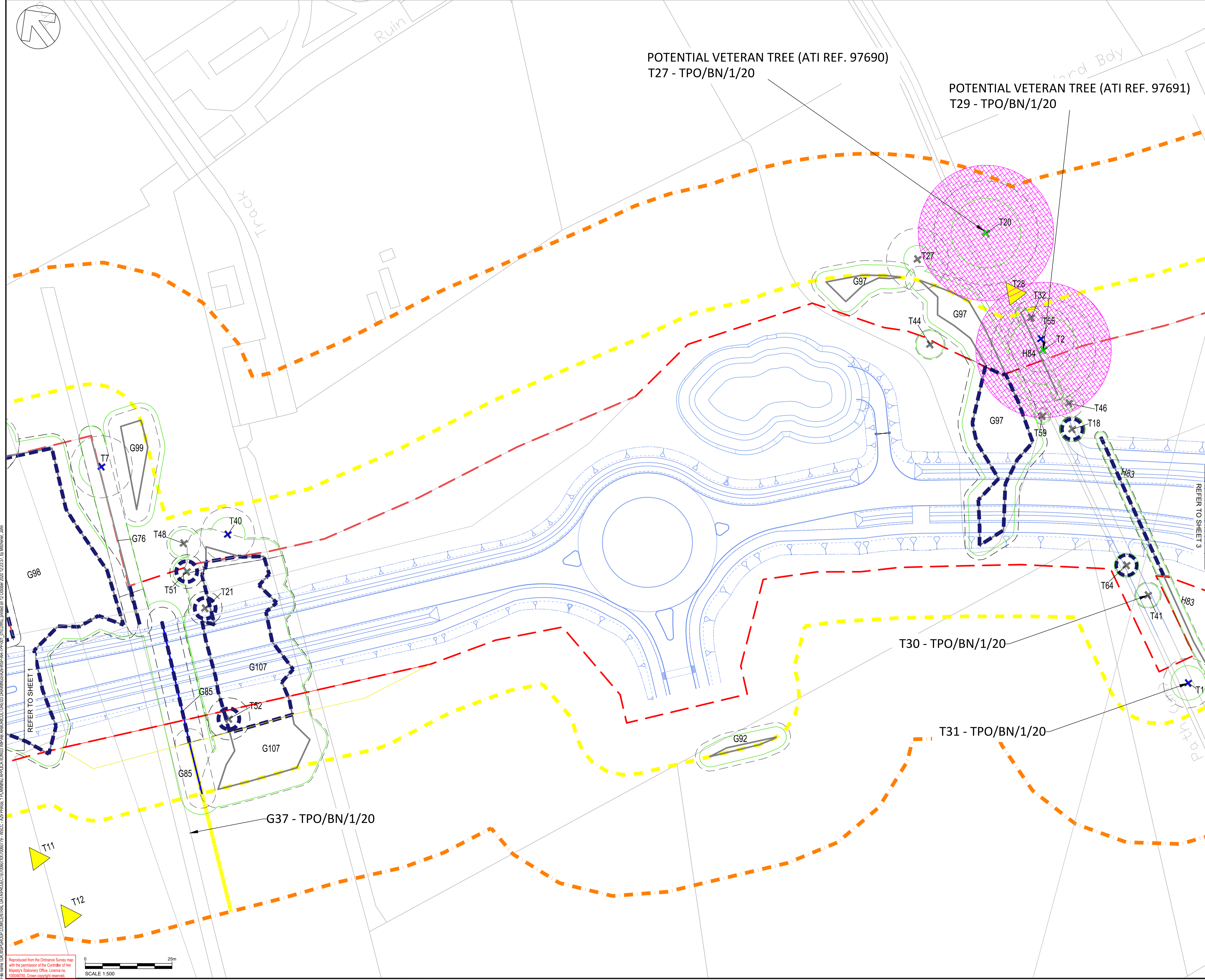

REV	DATE	BY	DESCRIPTION	CHK	APP
B	08/10/2020	JM	UPDATED RLB	CIT	ND
A	21/08/2020	JM	FIRST ISSUE	CIT	ND

DRAWING STATUS: **S3 - FOR REVIEW**

1 Capital Quarter, Tyndall St, Cardiff, CF10 4BZ, UK
T+ 44 (0) 292 076 9200
wsp.com

CLIENT: WEST SUSSEX COUNTY COUNCIL

ARCHITECT: -

SITE PROJECT: A29 REALIGNMENT PHASE 1

TITLE: TREE PROTECTION PLAN (TREE REMOVALS) (SHEET 2 OF 10)

SCALE @ A1:	1:500	CHECKED:	CIT	APPROVED:	ND
PROJECT NO:	70060779	DESIGNED:	JM	DRAWN:	JM
DATE:	October 20	REV:			

DRAWING No: A29-WSP-AR-TPP-002 REV: B
© WSP UK Ltd

File: \\wsp\wsp\group\COMMON\DATA\PROJECTS\70060779\AR\AR\AR\TPP002_010.DWG, created on 12 October 2020 12:23:37 by Michael_John

Reproduced from the Ordnance Survey map with the permission of the Controller of Her Majesty's Stationary Office. Licence no. 100048768. Crown copyright reserved.
SCALE 1:500

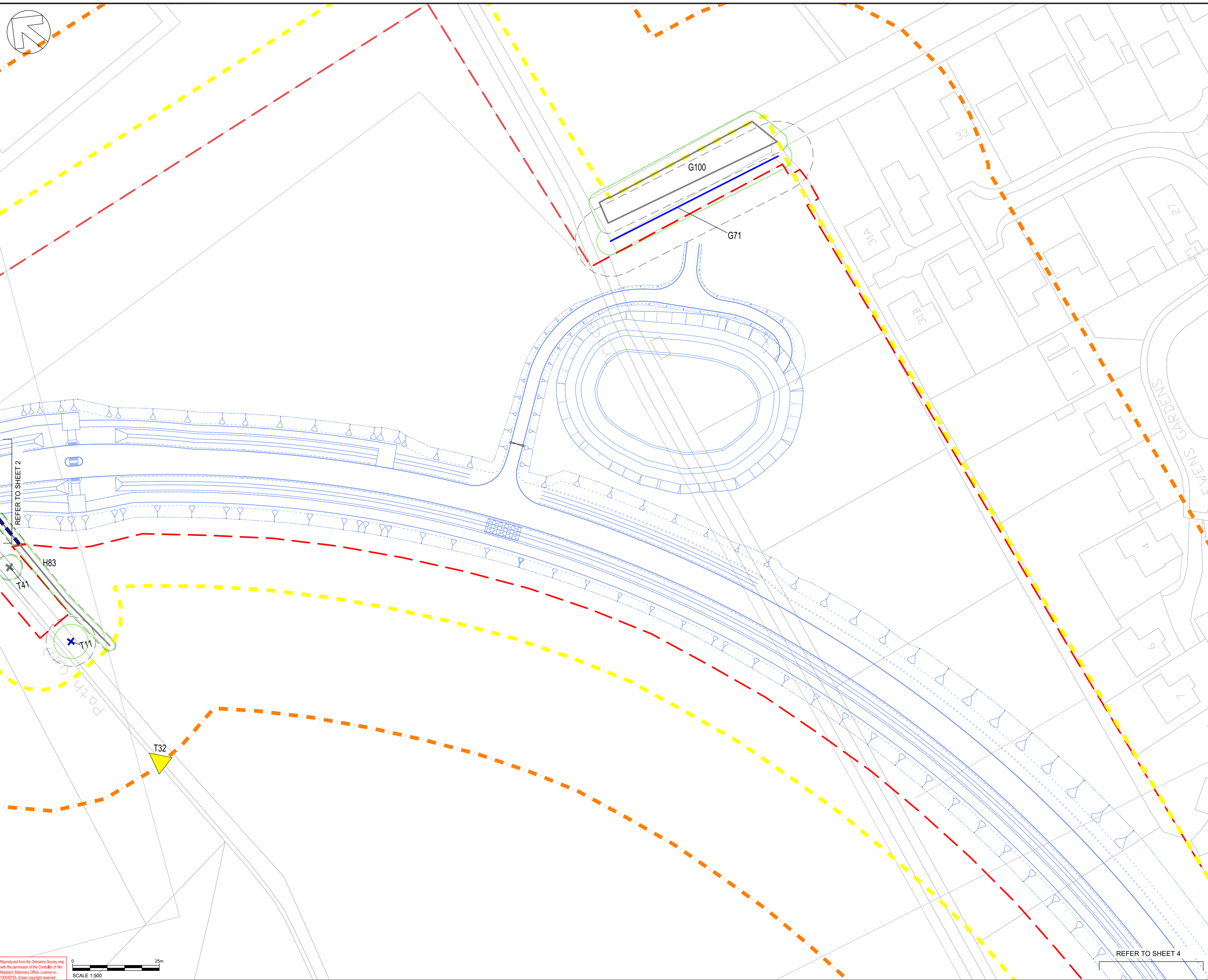

DO NOT SCALE

- NOTES:
1. ALL DIMENSIONS ARE IN METRES UNLESS OTHERWISE STATED.
 2. DO NOT SCALE, IF IN DOUBT CONTACT WSP PROJECT MANAGER.
 3. THE WORKS SHALL BE CARRIED OUT IN ACCORDANCE WITH THE DFT MCHW, DMRB AND THE LOCAL REQUIREMENTS OF WEST SUSSEX COUNTY COUNCIL DESIGN GUIDE & SPECIFICATIONS.

- KEY:
- T TREE
 - G TREE GROUP
 - H HEDGE
 - BS 8837 CATEGORY GRADING / QUALITY
 - + A CATEGORY / HIGH
 - + B CATEGORY / MODERATE
 - + C CATEGORY / LOW
 - ROOT PROTECTION AREA
 - ⊗ SEMI-NATURAL BUFFER - POTENTIAL VETERAN TREES
 - TREE CANOPY
 - ⊠ ARBORICULTURAL FEATURE TO BE REMOVED
 - ▲ TPO TREE (UN-SURVEYED)
 - ▲ TPO TREE GROUP (UN-SURVEYED)
 - ▲ TREE GROUP - UN-SURVEYED
 - ▭ PLANNING APPLICATION BOUNDARY
 - ▭ ARBORICULTURAL STUDY AREA (WALKOVER SURVEY)
 - ▭ ARBORICULTURAL STUDY AREA (DESK STUDY)

B	08/10/2020	JM	UPDATED RLB	CIT	ND
A	21/08/2020	JM	FIRST ISSUE	CIT	ND
REV	DATE	BY	DESCRIPTION	CHK	APP

DRAWING STATUS: **S3 - FOR REVIEW**

wsp

1 Capital Quarter, Tyndall St, Cardiff, CF10 4BZ, UK
T+ 44 (0) 292 076 9200
wsp.com

CLIENT: **WEST SUSSEX COUNTY COUNCIL**

ARCHITECT: -

SITE PROJECT: **A29 REALIGNMENT PHASE 1**

TITLE: **TREE PROTECTION PLAN (TREE REMOVALS) (SHEET 3 OF 10)**

SCALE @ A1:	1:500	CHECKED:	CIT	APPROVED:	ND
PROJECT NO:	70060779	DESIGNED:	JM	DRAWN:	JM
				DATE:	October 20

DRAWING No: **A29-WSP-AR-TPP-003** REV: **B**

© WSP UK Ltd

File: a29_wsp_group_commercial_data/projects/70060779/MSCC_A29/PHASE 1/PLANNING APPLICATIONS/WP/AR/ARBORICULTURE/03/WP/AR/ARBORICULTURE/DRAWINGS/3/WSP-AR-TPP-003_01.DWG, printed on 12 October 2020 12:23:42 by Mchabane, John

Reproduced from the Ordnance Survey map with the permission of the Controller of Her Majesty's Stationary Office. Licence no. 100048756. Crown copyright reserved.

SCALE 1:500

REFER TO SHEET 4

REFER TO SHEET 2

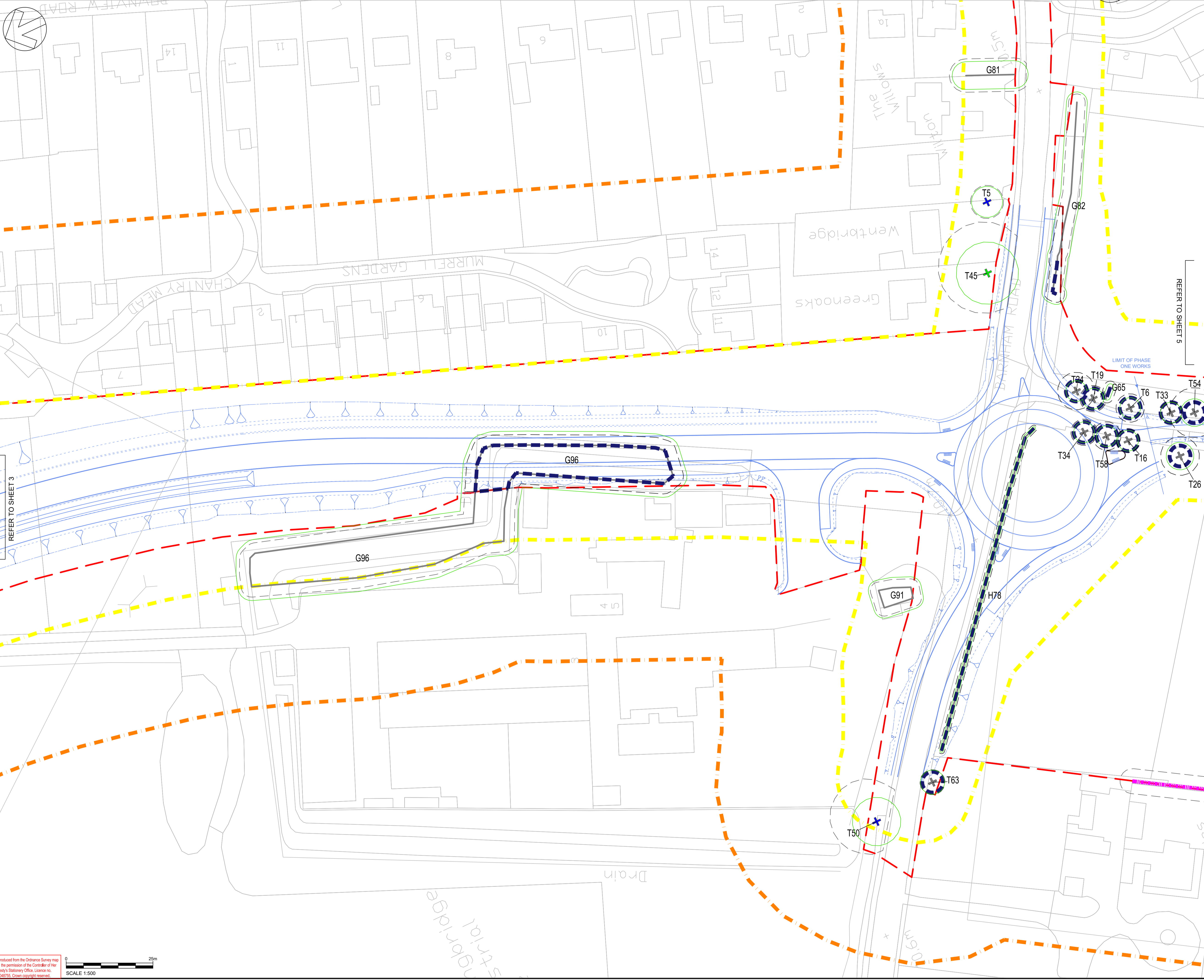

DO NOT SCALE

- NOTES:
1. ALL DIMENSIONS ARE IN METRES UNLESS OTHERWISE STATED.
 2. DO NOT SCALE, IF IN DOUBT CONTACT WSP PROJECT MANAGER.
 3. THE WORKS SHALL BE CARRIED OUT IN ACCORDANCE WITH THE DFT MCHW, DMRB AND THE LOCAL REQUIREMENTS OF WEST SUSSEX COUNTY COUNCIL DESIGN GUIDE & SPECIFICATIONS.

- KEY:
- T TREE
 - G TREE GROUP
 - H HEDGE
- BS 8837 CATEGORY GRADING / QUALITY
- + A CATEGORY / HIGH
 - + B CATEGORY / MODERATE
 - + C CATEGORY / LOW
- ROOT PROTECTION AREA
 - SEMI-NATURAL BUFFER - POTENTIAL VETERAN TREES
 - TREE CANOPY
- ▭ ARBORICULTURAL FEATURE TO BE REMOVED
 - △ TPO TREE (UN-SURVEYED)
 - △ TPO TREE GROUP (UN-SURVEYED)
 - △ TREE GROUP - UN-SURVEYED
 - ▭ PLANNING APPLICATION BOUNDARY
 - ▭ ARBORICULTURAL STUDY AREA (WALKOVER SURVEY)
 - ▭ ARBORICULTURAL STUDY AREA (DESK STUDY)

B	08/10/2020	JM	UPDATED RLB	CIT	ND
A	21/08/2020	JM	FIRST ISSUE	CIT	ND
REV	DATE	BY	DESCRIPTION	CHK	APP

DRAWING STATUS: **S3 - FOR REVIEW**

1 Capital Quarter, Tyndall St, Cardiff, CF10 4BZ, UK
T+ 44 (0) 292 076 9200
wsp.com

CLIENT: WEST SUSSEX COUNTY COUNCIL

ARCHITECT: -

SITE PROJECT: A29 REALIGNMENT PHASE 1

TITLE: TREE PROTECTION PLAN (TREE REMOVALS) (SHEET 4 OF 10)

SCALE @ A1:	1:500	CHECKED:	CIT	APPROVED:	ND
PROJECT NO:	70060779	DESIGNED:	JM	DRAWN:	JM
				DATE:	October 20

DRAWING No: A29-WSP-AR-TPP-004 REV: B

© WSP UK Ltd

File: \\wsp\group\COMMON\DATA\PROJECTS\70060779\WSP-AR-TPP-010.DWG, printed on 12 October 2020 12:23:48 by Michael John

Reproduced from the Ordnance Survey map with the permission of the Controller of Her Majesty's Stationary Office. Licence no. 100048735. Crown copyright reserved.

SCALE 1:500

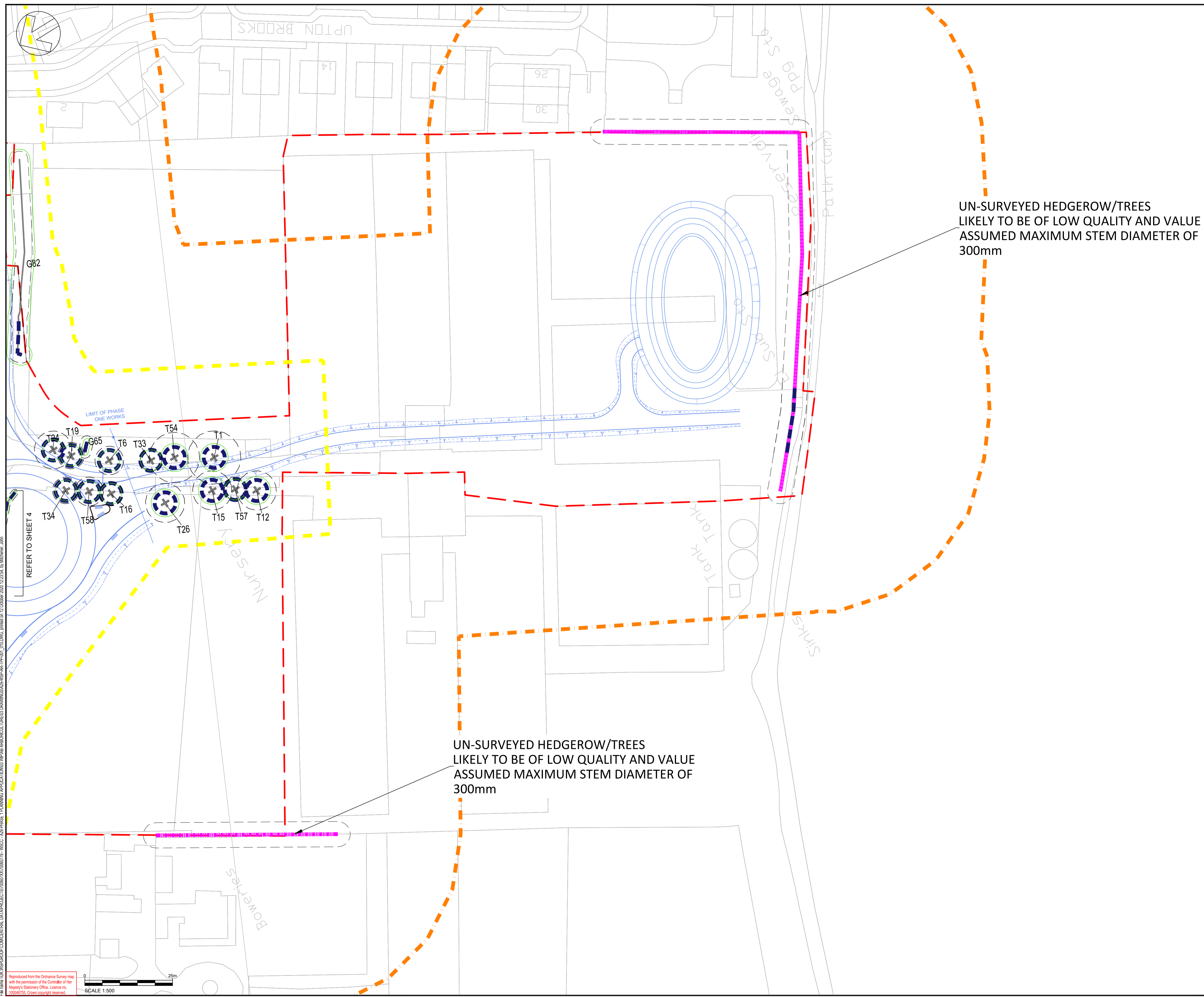

UN-SURVEYED HEDGEROW/TREES
 LIKELY TO BE OF LOW QUALITY AND VALUE
 ASSUMED MAXIMUM STEM DIAMETER OF
 300mm

UN-SURVEYED HEDGEROW/TREES
 LIKELY TO BE OF LOW QUALITY AND VALUE
 ASSUMED MAXIMUM STEM DIAMETER OF
 300mm

DO NOT SCALE

- NOTES:
1. ALL DIMENSIONS ARE IN METRES UNLESS OTHERWISE STATED.
 2. DO NOT SCALE, IF IN DOUBT CONTACT WSP PROJECT MANAGER.
 3. THE WORKS SHALL BE CARRIED OUT IN ACCORDANCE WITH THE DFT MCHW, DMRB AND THE LOCAL REQUIREMENTS OF WEST SUSSEX COUNTY COUNCIL DESIGN GUIDE & SPECIFICATIONS.

- KEY:
- T TREE
 - G TREE GROUP
 - H HEDGE
 - BS 5837 CATEGORY GRADING / QUALITY
 - A CATEGORY / HIGH
 - B CATEGORY / MODERATE
 - C CATEGORY / LOW
 - ROOT PROTECTION AREA
 - SEMI-NATURAL BUFFER - POTENTIAL VETERAN TREES
 - TREE CANOPY
 - ARBORICULTURAL FEATURE TO BE REMOVED
 - TPO TREE (UN-SURVEYED)
 - TPO TREE GROUP (UN-SURVEYED)
 - TREE GROUP - UN-SURVEYED
 - PLANNING APPLICATION BOUNDARY
 - ARBORICULTURAL STUDY AREA (WALKOVER SURVEY)
 - ARBORICULTURAL STUDY AREA (DESK STUDY)

REV	DATE	BY	DESCRIPTION	CHK	APP
B	08/10/2020	JM	UPDATED RLB	CIT	ND
A	21/08/2020	JM	FIRST ISSUE	CIT	ND

DRAWING STATUS: S3 - FOR REVIEW

1 Capital Quarter, Tyndall St, Cardiff, CF10 4BZ, UK
 T+44 (0) 292 076 9200
 wsp.com

CLIENT: WEST SUSSEX COUNTY COUNCIL

ARCHITECT:

SITE PROJECT: A29 REALIGNMENT PHASE 1

TITLE: TREE PROTECTION PLAN (TREE REMOVALS)
 (SHEET 5 OF 10)

SCALE @ A1:	CHECKED:	APPROVED:
1:500	CIT	ND

PROJECT NO.:	DESIGNED:	DRAWN:	DATE:
70060779	JM	JM	October 20

DRAWING No: A29-WSP-AR-TPP-005 REV: B

© WSP UK Ltd

File: \\wsp\group\COMMON\DATA\PROJECTS\2020\07\060779\A29\AR\TPP-005\ARBORICULTURE\DRAWINGS\A29-WSP-AR-TPP-005.dwg, printed on 12 October 2020 12:23:54, by Michael John
 Reproduced from the Ordnance Survey map with the permission of the Controller of Her Majesty's Stationary Office. Licence no. 100048756. Crown copyright reserved.

DO NOT SCALE

- NOTES:
1. ALL DIMENSIONS ARE IN METRES UNLESS OTHERWISE STATED.
 2. DO NOT SCALE, IF IN DOUBT CONTACT WSP PROJECT MANAGER.
 3. THE WORKS SHALL BE CARRIED OUT IN ACCORDANCE WITH THE DFT MCHW, DMRB AND THE LOCAL REQUIREMENTS OF WEST SUSSEX COUNTY COUNCIL DESIGN GUIDE & SPECIFICATIONS.

- KEY:
- T TREE
 - G TREE GROUP
 - H HEDGE
- BS 5827 CATEGORY GRADING / QUALITY
- + A CATEGORY / HIGH
 - + B CATEGORY / MODERATE
 - + C CATEGORY / LOW
- ROOT PROTECTION AREA
 - SEMI-NATURAL BUFFER - POTENTIAL VETERAN TREES
 - TREE CANOPY
- ▭ TREE PROTECTION FENCING
 - ▭ AREA OF MAXIMUM VEGETATION RETENTION WHERE POSSIBLE
 - ▲ TPO TREE (UN-SURVEYED)
 - ▲ TPO TREE GROUP (UN-SURVEYED)
 - ▲ TREE GROUP - UN-SURVEYED
 - ▭ PLANNING APPLICATION BOUNDARY
 - ▭ ARBORICULTURAL STUDY AREA (WALKOVER SURVEY)
 - ▭ ARBORICULTURAL STUDY AREA (DESK STUDY)

REV	DATE	BY	DESCRIPTION	CHK	APP
B	08/10/2020	JM	UPDATED RLB	CIT	ND
A	21/08/2020	JM	FIRST ISSUE	CIT	ND

DRAWING STATUS: **S3 - FOR REVIEW**



1 Capital Quarter, Tyndall St, Cardiff, CF10 4BZ, UK
T+ 44 (0) 292 076 9200
wsp.com

CLIENT: **WEST SUSSEX COUNTY COUNCIL**

ARCHITECT: -

SITE PROJECT: **A29 REALIGNMENT PHASE 1**

TITLE: **TREE PROTECTION PLAN (SHEET 6 OF 10)**

SCALE @ A1:	CHECKED:	APPROVED:	
1:500	CIT	ND	
PROJECT NO:	DESIGNED:	DRAWN:	DATE:
70060779	JM	JM	October 20

DRAWING No: **A29-WSP-AR-TPP-006** REV: **B**

© WSP UK Ltd

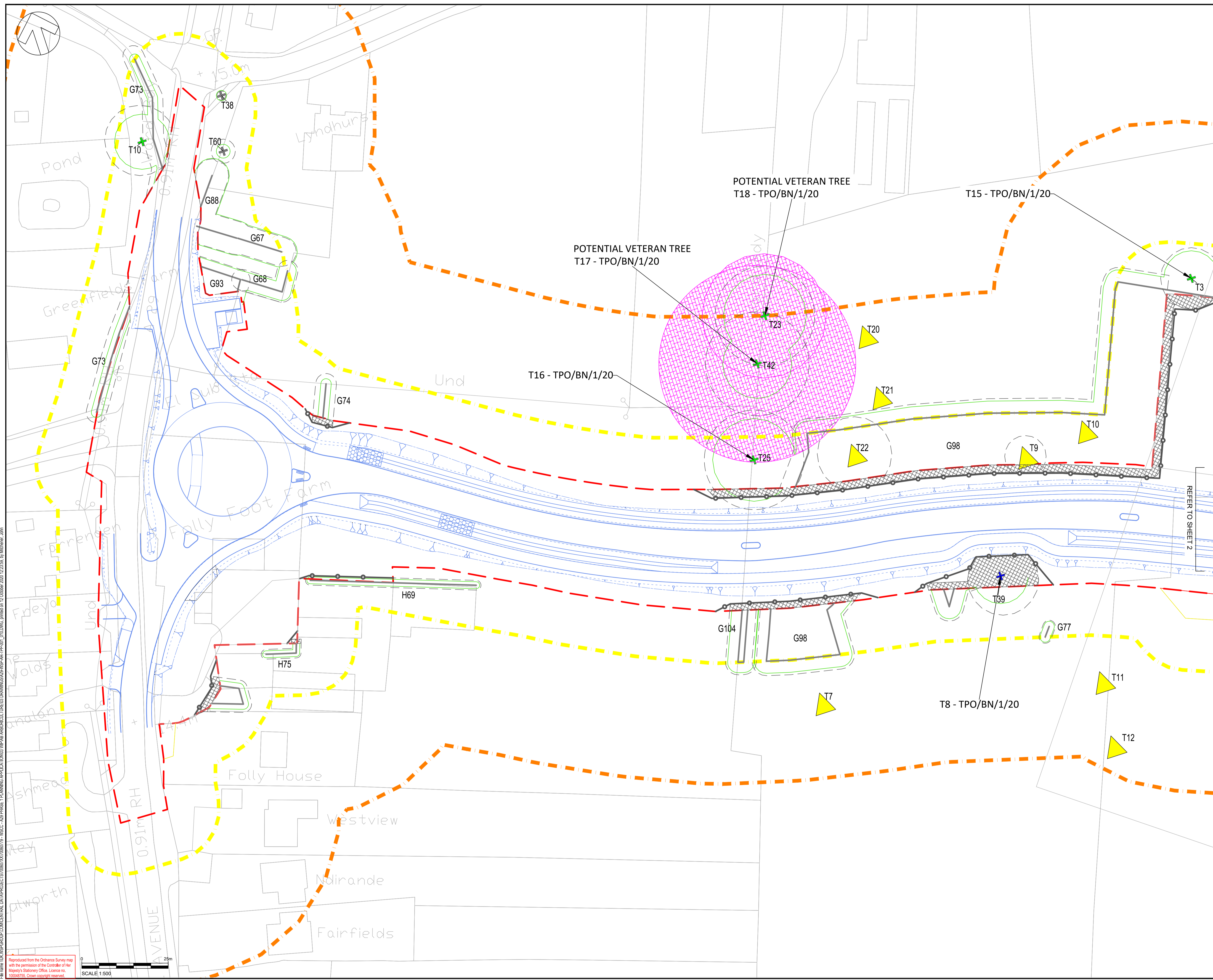

File: \\wsp\group\commercial_data\projects\70060779\70060779_01\DRAWING\REVISED\DRAWINGS\AR-TPP-006_01.DWG, printed on 11 October 2020 12:23:59 by Michael John
 Reproduced from the Ordnance Survey map with the permission of the Controller of Her Majesty's Stationary Office. Licence no. 100048755. Crown copyright reserved.

SCALE: 1:500

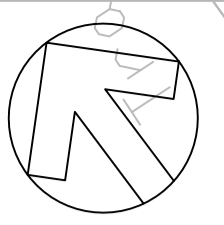

DO NOT SCALE

- NOTES:
1. ALL DIMENSIONS ARE IN METRES UNLESS OTHERWISE STATED.
 2. DO NOT SCALE, IF IN DOUBT CONTACT WSP PROJECT MANAGER.
 3. THE WORKS SHALL BE CARRIED OUT IN ACCORDANCE WITH THE DFT MCHW, DMRB AND THE LOCAL REQUIREMENTS OF WEST SUSSEX COUNTY COUNCIL DESIGN GUIDE & SPECIFICATIONS.

- KEY:
- T TREE
 - G TREE GROUP
 - H HEDGE
- BS 5837 CATEGORY GRADING / QUALITY
- A CATEGORY / HIGH
 - B CATEGORY / MODERATE
 - C CATEGORY / LOW
- ROOT PROTECTION AREA
 - SEMI-NATURAL BUFFER - POTENTIAL VETERAN TREES
 - TREE CANOPY
 - TREE PROTECTION FENCING
 - AREA OF MAXIMUM VEGETATION RETENTION WHERE POSSIBLE
 - TPO TREE (UN-SURVEYED)
 - TPO TREE GROUP (UN-SURVEYED)
 - TREE GROUP - UN-SURVEYED
 - PLANNING APPLICATION BOUNDARY
 - ARBORICULTURAL STUDY AREA (WALKOVER SURVEY)
 - ARBORICULTURAL STUDY AREA (DESK STUDY)

POTENTIAL VETERAN TREE (ATI REF. 97690)
T27 - TPO/BN/1/20

POTENTIAL VETERAN TREE (ATI REF. 97691)
T29 - TPO/BN/1/20

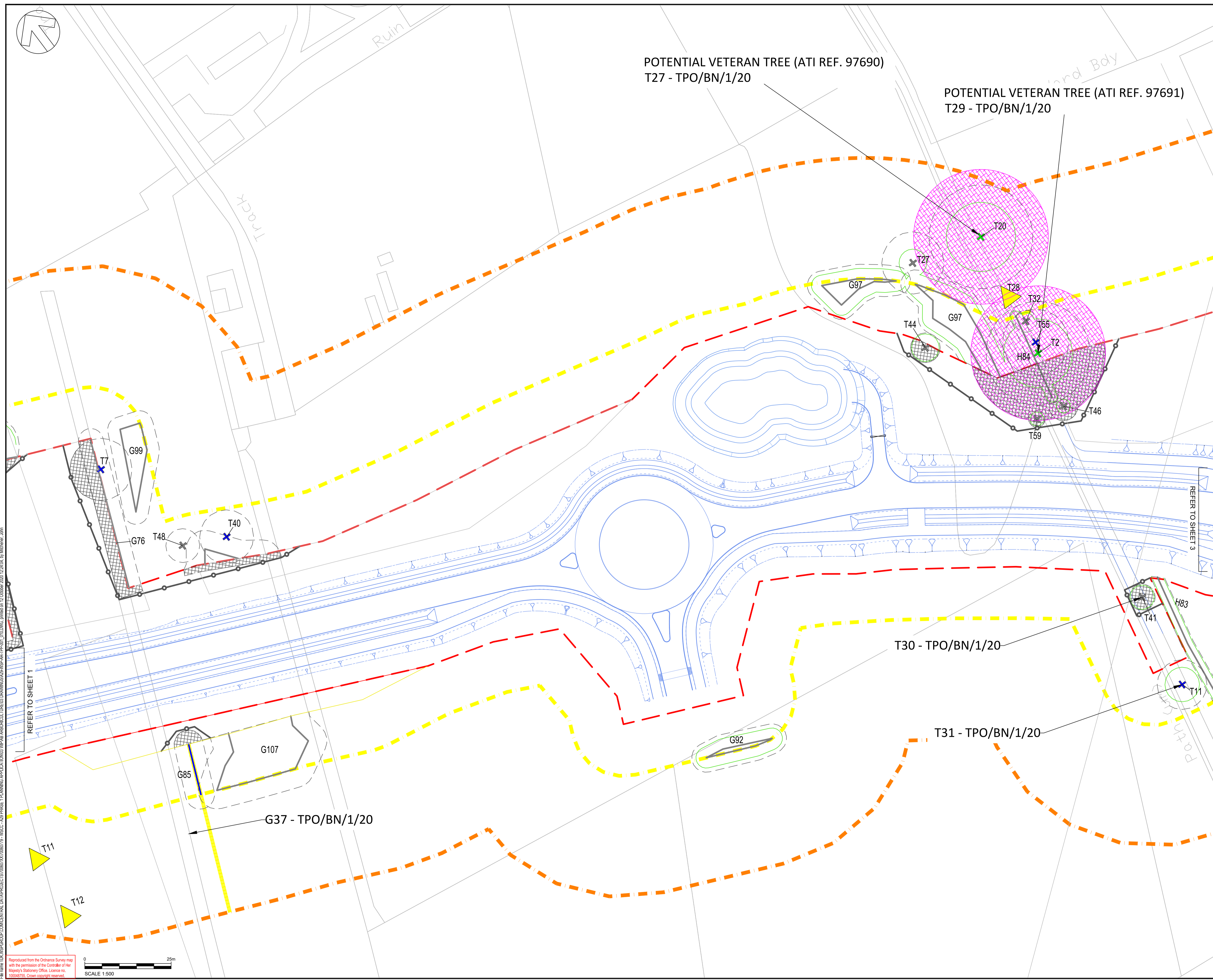

REV	DATE	BY	DESCRIPTION	CHK	APP
B	08/10/2020	JM	UPDATED RLB	CIT	ND
A	21/08/2020	JM	FIRST ISSUE	CIT	ND

DRAWING STATUS: S3 - FOR REVIEW

1 Capital Quarter, Tyndall St, Cardiff, CF10 4BZ, UK
T+ 44 (0) 292 076 9200
wsp.com

CLIENT: WEST SUSSEX COUNTY COUNCIL

ARCHITECT: -

SITE PROJECT: A29 REALIGNMENT PHASE 1

TITLE: TREE PROTECTION PLAN (SHEET 7 OF 10)

SCALE @ A1:	CHECKED:	APPROVED:
1:500	CIT	ND

PROJECT NO:	DESIGNED:	DRAWN:	DATE:
70060779	JM	JM	October 20

DRAWING No: A29-WSP-AR-TPP-007 REV: B

© WSP UK Ltd

File: \\wsp\group\COMMON\DATA\PROJECTS\70060779\A29\AR\AR-TPP-010.DWG, created on 17 October 2020 12:24:04, by Michael John

Reproduced from the Ordnance Survey map with the permission of the Controller of Her Majesty's Stationary Office. Licence no. 100048756. Crown copyright reserved.

SCALE 1:500

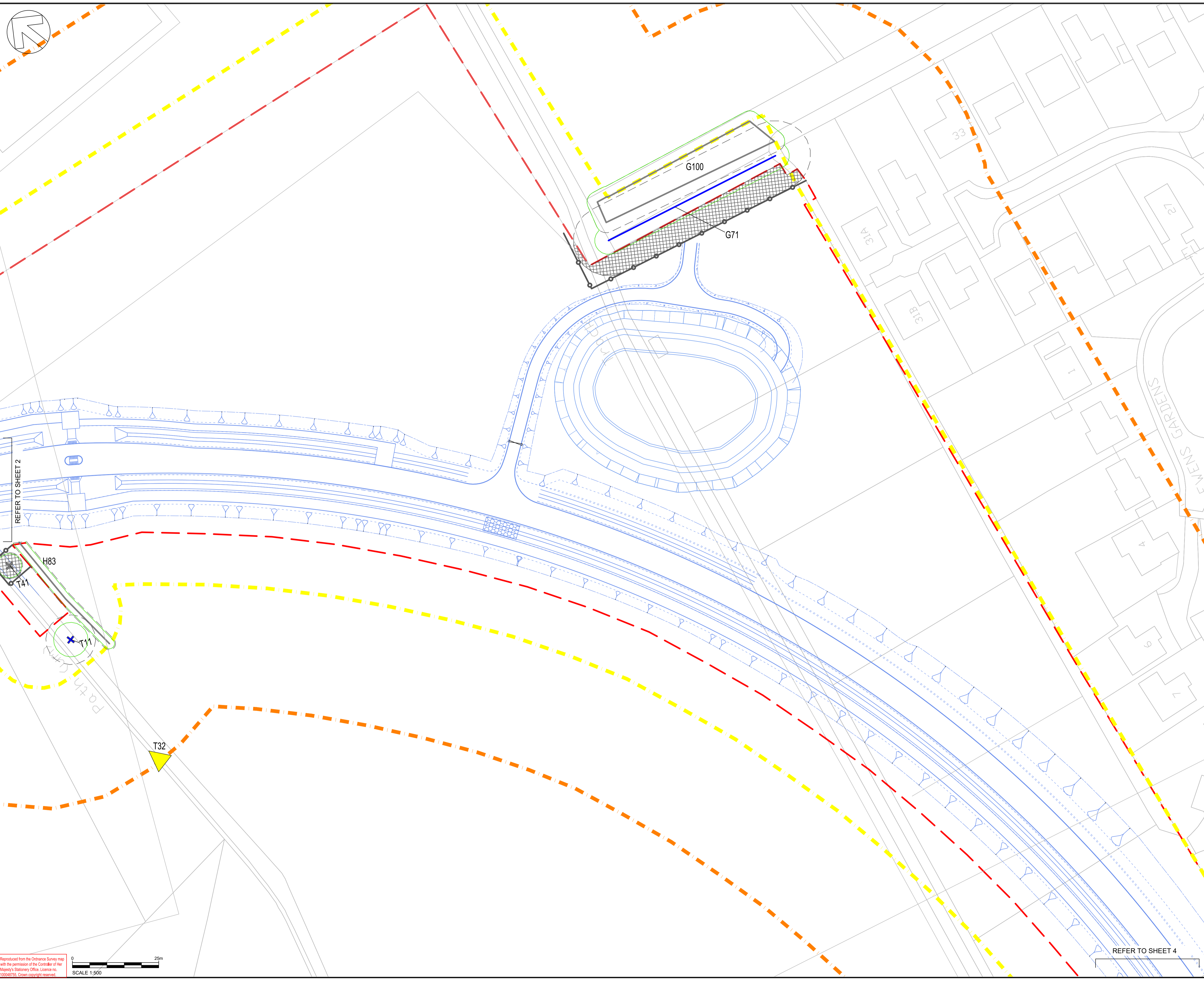

DO NOT SCALE

- NOTES:
1. ALL DIMENSIONS ARE IN METRES UNLESS OTHERWISE STATED.
 2. DO NOT SCALE, IF IN DOUBT CONTACT WSP PROJECT MANAGER.
 3. THE WORKS SHALL BE CARRIED OUT IN ACCORDANCE WITH THE DFT MCHW, DMRB AND THE LOCAL REQUIREMENTS OF WEST SUSSEX COUNTY COUNCIL DESIGN GUIDE & SPECIFICATIONS.

- KEY:
- T TREE
 - G TREE GROUP
 - H HEDGE
- BS 5827 CATEGORY GRADING / QUALITY
- + A CATEGORY / HIGH
 - + B CATEGORY / MODERATE
 - + C CATEGORY / LOW
- ROOT PROTECTION AREA
 - SEMI-NATURAL BUFFER - POTENTIAL VETERAN TREES
 - TREE CANOPY
 - ▭ TREE PROTECTION FENCING
 - ▭ AREA OF MAXIMUM VEGETATION RETENTION WHERE POSSIBLE
 - ▲ TPO TREE (UN-SURVEYED)
 - ▲ TPO TREE GROUP (UN-SURVEYED)
 - ▲ TREE GROUP - UN-SURVEYED
 - ▭ PLANNING APPLICATION BOUNDARY
 - ▭ ARBORICULTURAL STUDY AREA (WALKOVER SURVEY)
 - ▭ ARBORICULTURAL STUDY AREA (DESK STUDY)

REV	DATE	BY	DESCRIPTION	CHK	APP
B	08/10/2020	JM	UPDATED RLB	CIT	ND
A	21/08/2020	JM	FIRST ISSUE	CIT	ND

DRAWING STATUS: **S3 - FOR REVIEW**



1 Capital Quarter, Tyndall St, Cardiff, CF10 4BZ, UK
T+ 44 (0) 292 076 9200
wsp.com

CLIENT: **WEST SUSSEX COUNTY COUNCIL**

ARCHITECT: -

SITE PROJECT: **A29 REALIGNMENT PHASE 1**

TITLE: **TREE PROTECTION PLAN (SHEET 8 OF 10)**

SCALE @ A1:	CHECKED:	APPROVED:
1:500	CIT	ND
PROJECT NO:	DESIGNED:	DRAWN:
70060779	JM	JM
DRAWING No:	DATE:	REV:
A29-WSP-AR-TPP-008	October 20	B

© WSP UK Ltd

File: \\wsp\group\COMMON\DATA\PROJECTS\70060779\WSP-AR-TPP-010\DRAWING\REVISED DRAWINGS\A29-AR-TPP-010_01.DWG, printed on 12 October 2020 12:24:08 by Michael John

Reproduced from the Ordnance Survey map with the permission of the Controller of Her Majesty's Stationary Office. Licence no. 100048735. Crown copyright reserved.

SCALE 1:500

REFER TO SHEET 2

REFER TO SHEET 4

DO NOT SCALE

- NOTES:
1. ALL DIMENSIONS ARE IN METRES UNLESS OTHERWISE STATED.
 2. DO NOT SCALE, IF IN DOUBT CONTACT WSP PROJECT MANAGER.
 3. THE WORKS SHALL BE CARRIED OUT IN ACCORDANCE WITH THE DFT MCHW, DMRB AND THE LOCAL REQUIREMENTS OF WEST SUSSEX COUNTY COUNCIL DESIGN GUIDE & SPECIFICATIONS.

- KEY:
- T TREE
 - G TREE GROUP
 - H HEDGE
- BS 5827 CATEGORY GRADING / QUALITY
- + A CATEGORY / HIGH
 - + B CATEGORY / MODERATE
 - + C CATEGORY / LOW
- ROOT PROTECTION AREA
 - SEMI-NATURAL BUFFER - POTENTIAL VETERAN TREES
 - TREE CANOPY
- ▭ TREE PROTECTION FENCING
 - ▭ AREA OF MAXIMUM VEGETATION RETENTION WHERE POSSIBLE
 - △ TPO TREE (UN-SURVEYED)
 - △ TPO TREE GROUP (UN-SURVEYED)
 - △ TREE GROUP - UN-SURVEYED
 - △ TREE GROUP - UN-SURVEYED
 - ▭ PLANNING APPLICATION BOUNDARY
 - ▭ ARBORICULTURAL STUDY AREA (WALKOVER SURVEY)
 - ▭ ARBORICULTURAL STUDY AREA (DESK STUDY)

REV	DATE	BY	DESCRIPTION	CHK	APP
B	08/10/2020	JM	UPDATED RLB	CIT	ND
A	21/08/2020	JM	FIRST ISSUE	CIT	ND

DRAWING STATUS: S3 - FOR REVIEW



1 Capital Quarter, Tyndall St, Cardiff, CF10 4BZ, UK
T+ 44 (0) 292 076 9200
wsp.com

CLIENT: WEST SUSSEX COUNTY COUNCIL

ARCHITECT: -

SITE PROJECT: A29 REALIGNMENT PHASE 1

TITLE: TREE PROTECTION PLAN (SHEET 9 OF 10)

SCALE @ A1:	CHECKED:	APPROVED:	
1:500	CIT	ND	
PROJECT NO:	DESIGNED:	DRAWN:	DATE:
70060779	JM	JM	October 20

DRAWING No: A29-WSP-AR-TPP-009 REV: B

© WSP UK Ltd

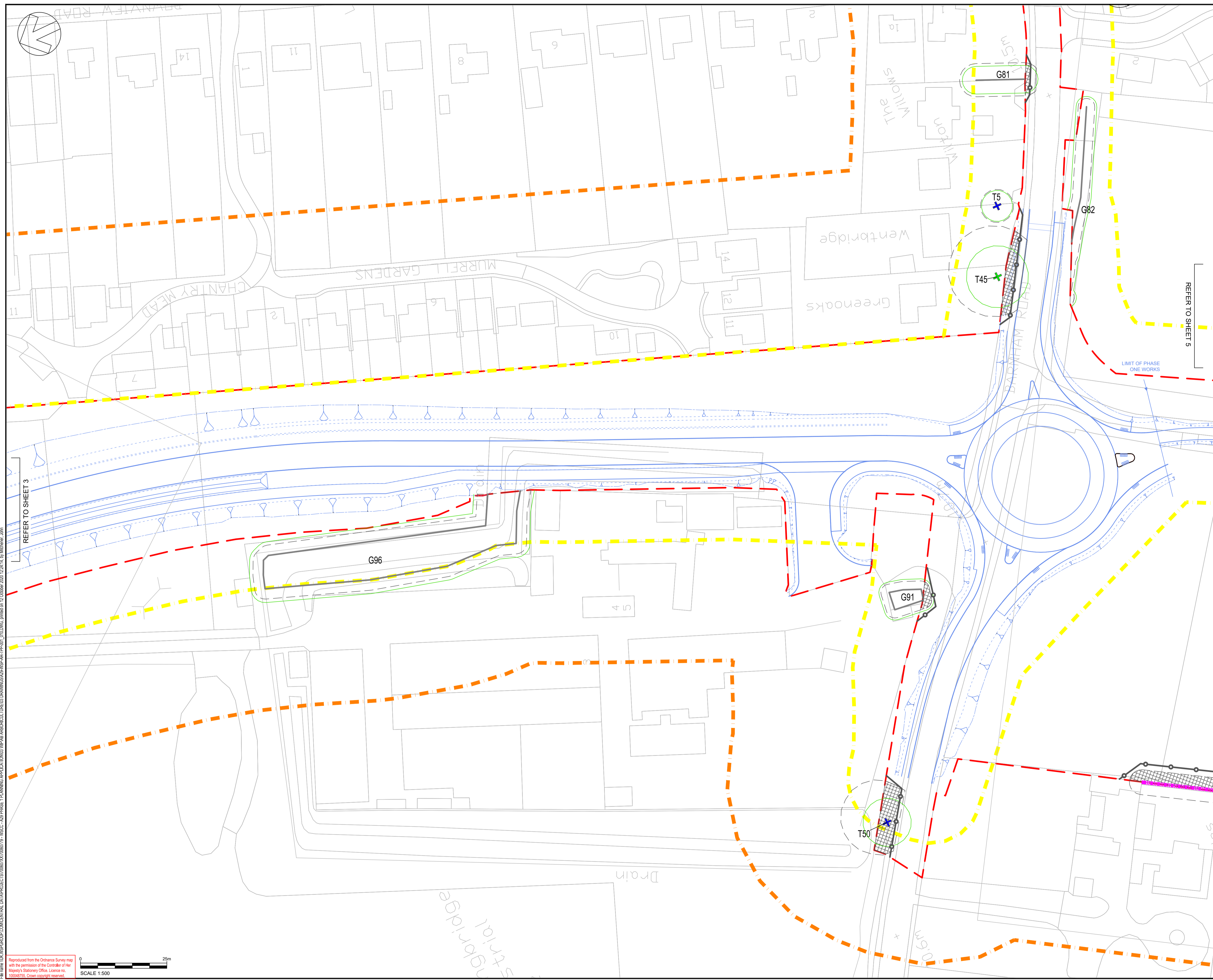

File: \\wsp\group\COMMON\DATA\PROJECTS\70060779\WSP-AR-TPP-010.DWG, printed on 12 October 2020 12:24:14, by Michael John
 Reproduced from the Ordnance Survey map with the permission of the Controller of Her Majesty's Stationary Office. Licence no. 100048735. Crown copyright reserved.

SCALE 1:500

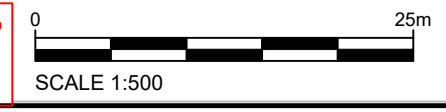

DO NOT SCALE

- NOTES:
1. ALL DIMENSIONS ARE IN METRES UNLESS OTHERWISE STATED.
 2. DO NOT SCALE, IF IN DOUBT CONTACT WSP PROJECT MANAGER.
 3. THE WORKS SHALL BE CARRIED OUT IN ACCORDANCE WITH THE DFT MCHW, DMRB AND THE LOCAL REQUIREMENTS OF WEST SUSSEX COUNTY COUNCIL DESIGN GUIDE & SPECIFICATIONS.

- KEY:
- T TREE
 - G TREE GROUP
 - H HEDGE
- BS 5837 CATEGORY GRADING / QUALITY
- + A CATEGORY / HIGH
 - + B CATEGORY / MODERATE
 - + C CATEGORY / LOW
- ROOT PROTECTION AREA
 - SEMI-NATURAL BUFFER - POTENTIAL VETERAN TREES
 - TREE CANOPY
- ▢ TREE PROTECTION FENCING
 - ▨ AREA OF MAXIMUM VEGETATION RETENTION WHERE POSSIBLE
 - ▲ TPO TREE (UN-SURVEYED)
 - ▨ TPO TREE GROUP (UN-SURVEYED)
 - ▨ TREE GROUP - UN-SURVEYED
 - ▭ PLANNING APPLICATION BOUNDARY
 - ▭ ARBORICULTURAL STUDY AREA (WALKOVER SURVEY)
 - ▭ ARBORICULTURAL STUDY AREA (DESK STUDY)

UN-SURVEYED HEDGEROW/TREES
LIKELY TO BE OF LOW QUALITY AND VALUE
ASSUMED MAXIMUM STEM DIAMETER OF
300mm

UN-SURVEYED HEDGEROW/TREES
LIKELY TO BE OF LOW QUALITY AND VALUE
ASSUMED MAXIMUM STEM DIAMETER OF
300mm

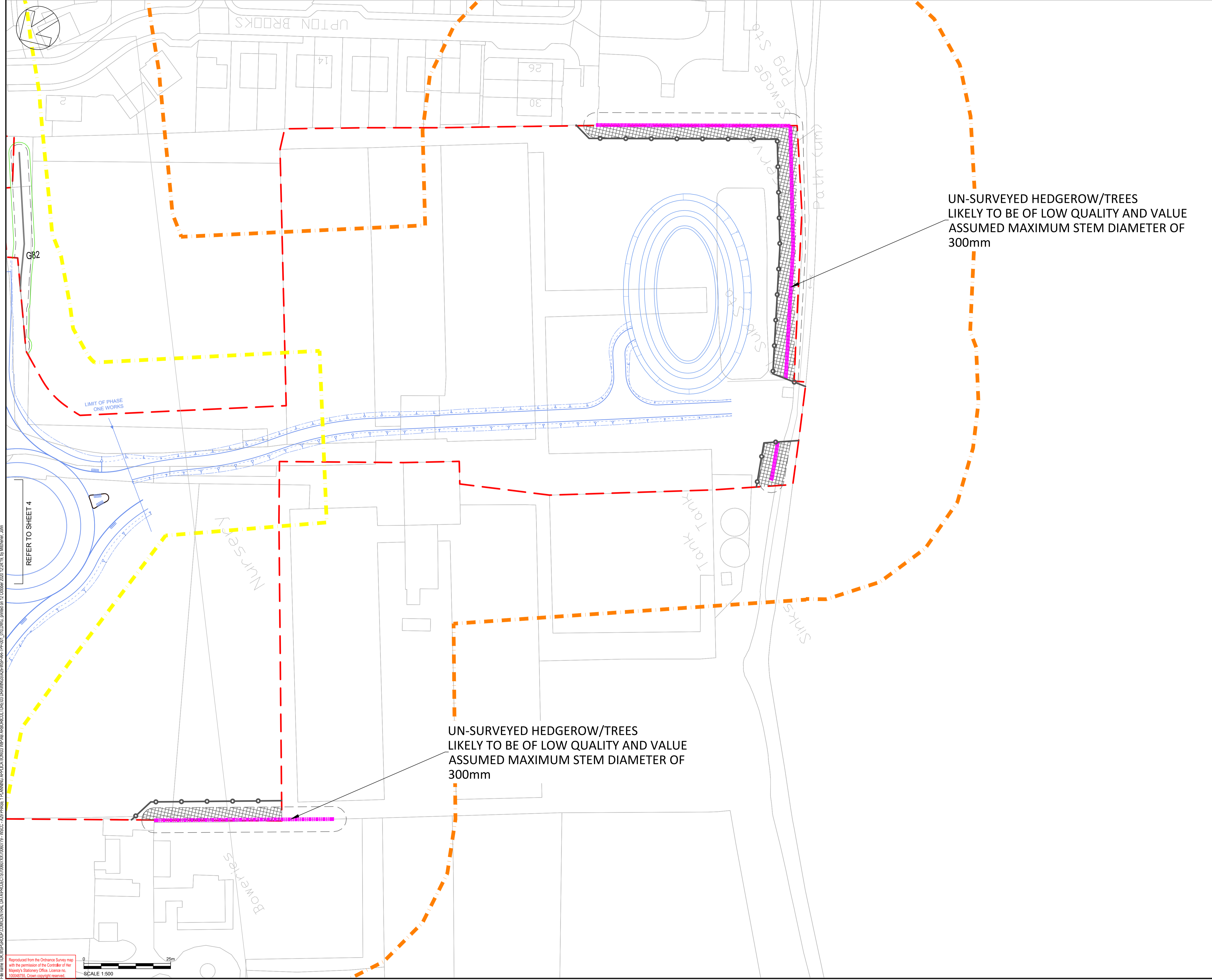

File path: \\uk.wspgroup.com\central_data\projects\70060779\060779\NSCC_A29\PHASE 1\PLANNING_APPLICATIONS\WPA8\ARBORICULTURE\TREE\DRAWINGS\A29\WSP-AR-TPP-010.DWG, printed on 12 October 2020 12:24:19 by Michael_John

Reproduced from the Ordnance Survey map with the permission of the Controller of Her Majesty's Stationary Office. Licence no. 100048755. Crown copyright reserved.

SCALE 1:500

REV	DATE	BY	DESCRIPTION	CHK	APP
B	08/10/2020	JM	UPDATED RLB	CIT	ND
A	21/08/2020	JM	FIRST ISSUE	CIT	ND

DRAWING STATUS: **S3 - FOR REVIEW**

1 Capital Quarter, Tyndall St, Cardiff, CF10 4BZ, UK
T+ 44 (0) 292 076 9200
wsp.com

CLIENT: WEST SUSSEX COUNTY COUNCIL

ARCHITECT: -

SITE PROJECT: **A29 REALIGNMENT PHASE 1**

TITLE: **TREE PROTECTION PLAN (SHEET 10 OF 10)**

SCALE @ A1: 1:500	CHECKED: CIT	APPROVED: ND
PROJECT NO: 70060779	DESIGNED: JM	DRAWN: JM
		DATE: October 20

DRAWING No: **A29-WSP-AR-TPP-010** REV: **B**

© WSP UK Ltd



1 Capital Quarter
Tyndall Street
Cardiff
CF10 4BZ

wsp.com